



# FLAMINGO ROAD AT KOVAL LANE BRIDGE STUDY

Prepared By:



April 2024

# TABLE OF CONTENTS

1.	INTRODUCTION .....	1
2.	OPERATION OF THE FLAMINGO ROAD/KOVAL LANE INTERSECTION WITH F1 TEMPORARY BRIDGE .....	2
3.	IMPROVING THE OPERATION OF THE KOVAL LANE INTERSECTION WITH A TEMPORARY BRIDGE IN PLACE.....	10
3.1	Alternative 1A - Improving the Traffic Signal Operation of the At-Grade Intersection with F1 Temporary Four-Lane Bridge .....	10
3.2	Alternative 1B - Improving the Traffic Signal Operation of the At-Grade Intersection and Adding an Eastbound Right-Turn Lane with F1 Temporary Four-Lane Bridge.....	10
3.3	Alternative 1C - Improving the Operation of the Koval Lane Intersection with an Eastbound Two-Lane Temporary Bridge and No Westbound Temporary Bridge .....	11
4.	ALTERNATIVE 2 - IMPROVING THE OPERATION OF THE KOVAL LANE INTERSECTION WITH A PERMANENT FOUR-LANE BRIDGE.....	17
5.	COMPARISON OF THE FLAMINGO ROAD/KOVAL LANE INTERSECTION OPERATIONS WITH AND WITHOUT A BRIDGE.....	19
6.	TRAFFIC DISRUPTION DURING THE ERECTION AND DISMANTLING OF THE TEMPORARY BRIDGE.....	21
7.	TRAFFIC DISRUPTION DURING THE CONSTRUCTION OF A PERMANENT four-lane BRIDGE .....	22
8.	ESTIMATED TRAVEL TIME BENEFITS (DISBENEFITS) .....	22
8.1	Estimated Travel Time Benefits (Disbenefits) of a Temporary Bridge.....	23
8.2	Estimated Travel Time Benefits (Disbenefits) of a Permanent Four-Lane Bridge.....	24
8.3	Comparison of Estimated Travel Time Benefits (Disbenefits) of Temporary Bridge vs. Permanent Bridge .....	28
9.	WIDENING OF KOVAL LANE TO SIX LANES .....	31
10.	TEMPORARY BRIDGE DESIGN OBSERVATIONS .....	31
11.	PERMANENT FOUR-Lane BRIDGE CONCEPT .....	32
12.	FLAMINGO ROAD CORRIDOR ANALYSIS .....	37
13.	FLAMINGO ROAD CORRIDOR ANALYSIS – ALTERNATIVE DESIGN WITH BRIDGE ONLY PROVIDING TWO LANES (ONE LANE IN EACH DIRECTION) OVER KOVAL LANE.....	43
14.	FLAMINGO ROAD CORRIDOR DIRECT AND INDIRECT IMPACTS.....	46
15.	CONCLUSIONS .....	49



## **1. INTRODUCTION**

The Formula 1 (F1) Las Vegas Grand Prix was held in Las Vegas, Nevada on November 16-18, 2023, along a track transversing the resort corridor. The track consisted of both Las Vegas Boulevard and Koval Lane between Sands Avenue and Harmon Avenue. A temporary bridge was required to be constructed on Flamingo Road over Koval Lane to provide vehicular access to the resorts within the track between Las Vegas Boulevard and Koval Lane. The temporary bridge also provided access to the Center Strip for emergency services from Clark County Fire Department Fire Station No. 18 located on Flamingo Road, east of Paradise Road. In October 2023, the temporary bridge was constructed by F1 and dismantled in January 2024.

The bridge was a metal structure so it could be stored, re-erected, and disassembled before and after future races, to provide the grade-separated crossing of Koval Lane. Based on current agreements, the potential exists for additional F1 races to be held each November through 2032, so that the temporary bridge could be erected and dismantled annually for the next 9 years.

The erection of the temporary bridge required the closure of Flamingo Road for 11 days, including the full closure of Koval Lane at the Flamingo Road/Koval Lane intersection for 5 days. A similar amount of time, and similar closures, were required to dismantle the bridge and restore normal street operations.

The temporary bridge carried four lanes, two lanes in each direction on Flamingo Road, unimpeded over Koval Lane. The existing lane configuration provides three lanes in each direction on Flamingo Road. East-west through traffic on Flamingo Road

benefited by not stopping at the signalized intersection with Koval Lane. A single at-grade lane was provided along each side of the bridge, to provide access to and from Koval Lane.

With the temporary bridge in place, the at-grade signalized Flamingo Road/Koval Lane intersection under the bridge was reconfigured to maintain two through lanes in each direction on Koval Lane, with single left-turn and right-turn lanes to Flamingo Road. The at-grade intersection was operated with split phasing, on a 226 second cycle (3-minutes 46-seconds). In other words, the traffic signal operated with four (4) phases, with each of the four approaches having its own phase lasting approximately 56 seconds. Normal traffic signal cycles in Las Vegas range from 160 to 180 seconds, so the wait times at the at-grade intersection were 46 to 66 seconds longer than normal. Pedestrian crosswalks on the south, east, and north legs of the intersection allowed pedestrians to cross the intersection with each through phase, but in conflict with right-turn vehicular movements.

The purpose of this report is to assess and evaluate the following:

1. Flamingo Road temporary bridge, including possible travel benefits to motorists and the disruption of traffic attributable to the erection, operation, and dismantling of the temporary bridge.
2. Possible improvements to improve traffic flow at the at-grade Flamingo Road/Koval Lane intersection with the temporary bridge.
3. Potential travel benefits that could be achieved with a permanent Flamingo Road bridge over Koval Lane, including the disruption of traffic that would be attributable to the construction of a permanent bridge.



## 2. OPERATION OF THE FLAMINGO ROAD/KOVAL LANE INTERSECTION WITH F1 TEMPORARY BRIDGE

An aerial view of the existing Flamingo Road/Koval Lane intersection is shown in Figure 1. The existing intersection lane configuration and traffic signal phasing is shown graphically in Figure 2. Figure 2 shows a Google Earth photo of the Flamingo Road/Koval Lane intersection when the temporary bridge was in-place.

Figure 4 graphically shows the lane configuration and traffic signal phasing that was used for the at-grade intersection with the F1 temporary bridge for the 2023 Race. The F1 Configuration of the at-grade Flamingo Road/Koval Lane intersection consisted of the following:

- Northbound Koval Lane: two through lanes, one left-turn lane, and one right-turn lane,
- Southbound Koval Lane: two through lanes, one left-turn lane, and one right-turn lane,
- Eastbound Flamingo Road: One single lane for combined left, right, and through movements,
- Westbound Flamingo Road: One lane for left and through movements, and one lane for right-turn movements, and
- Pedestrian crosswalks on the south, east, and north legs of the intersection.

In 2016, the Clark County Department of Public Works conducted a comprehensive traffic count program on the Flamingo Road Corridor from Las Vegas Boulevard to Paradise Road. Additionally, the Nevada Department of Transportation (NDOT) annually

records traffic counts on Flamingo Road. The most recent NDOT traffic counts, taken in June 2022, indicate that traffic on Flamingo Road has recovered from low traffic volumes of the pandemic era and have returned to 2016 levels. Therefore, the 2016 traffic counts are considered to be representative of traffic in the Flamingo Road Corridor under “normal” conditions, without a temporary bridge over Koval Lane. The normal (year 2016) peak hour traffic counts are shown in Figure 5.

As part of this study, peak-hour traffic counts were taken on January 4, 2024, with the temporary bridge in place and are also shown in Figure 5. The traffic counts found that 1,533 vehicles in the AM peak hour and 1,850 vehicles in the PM peak hour used the temporary bridge to cross over Koval Lane. The following observations were made regarding the traffic volume passing through the Flamingo Road/Koval Lane intersection with the F1 Configuration compared with the existing intersection under normal conditions:

- Total volume of traffic passing through and over the Flamingo Road/Koval Lane intersection was 44% lower than normal in the AM peak hour and 31% lower than normal in the PM peak hour.
- Flamingo Road peak hour traffic using the temporary bridge to cross over Koval Lane was 30% lower in the AM peak hour and 33% lower during the PM peak hour than normal at-grade Flamingo Road through movements.



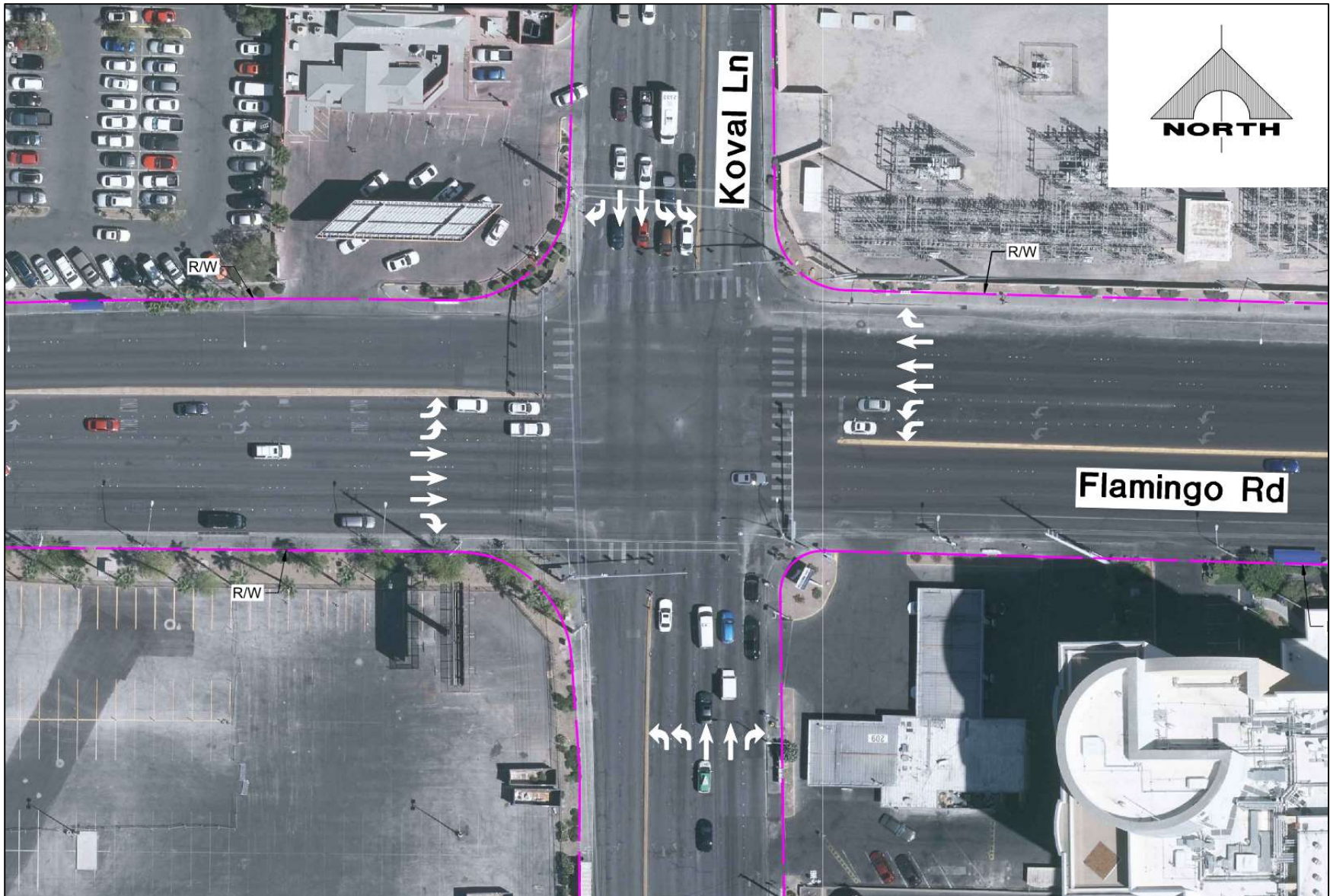

Figure 1. Aerial View of Existing Flamingo Road and Koval Lane Intersection

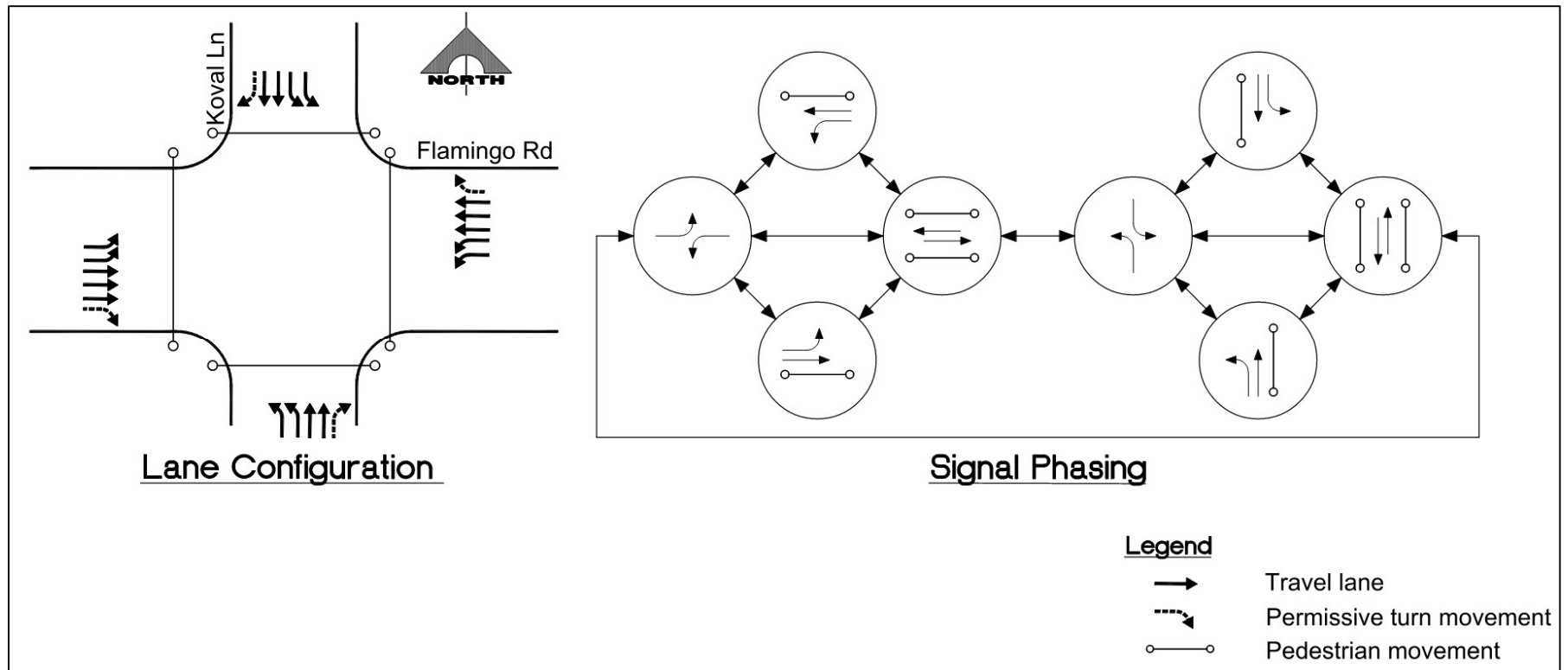
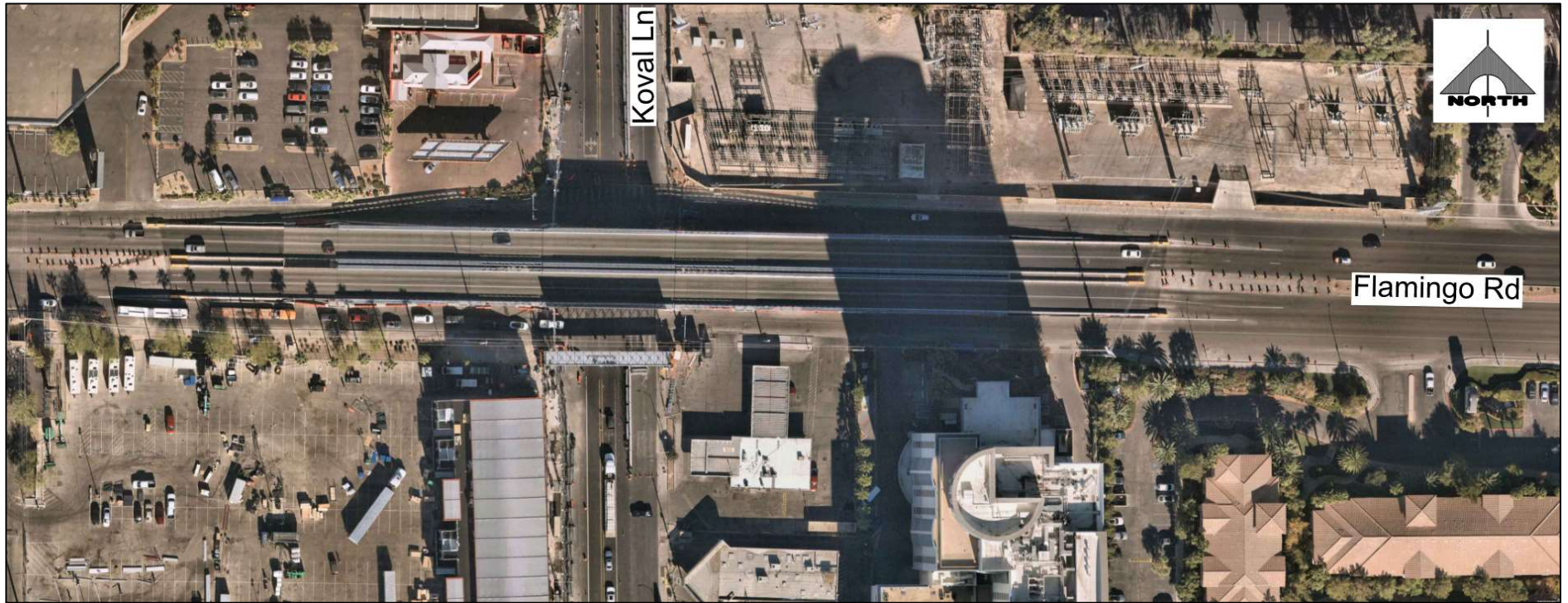

Figure 2. Existing At-Grade Intersection Lane Configuration and Traffic Signal Phasing



**Figure 3. Photo of 2023 F1 Configuration Temporary Bridge carrying Flamingo Road over Koval Lane**

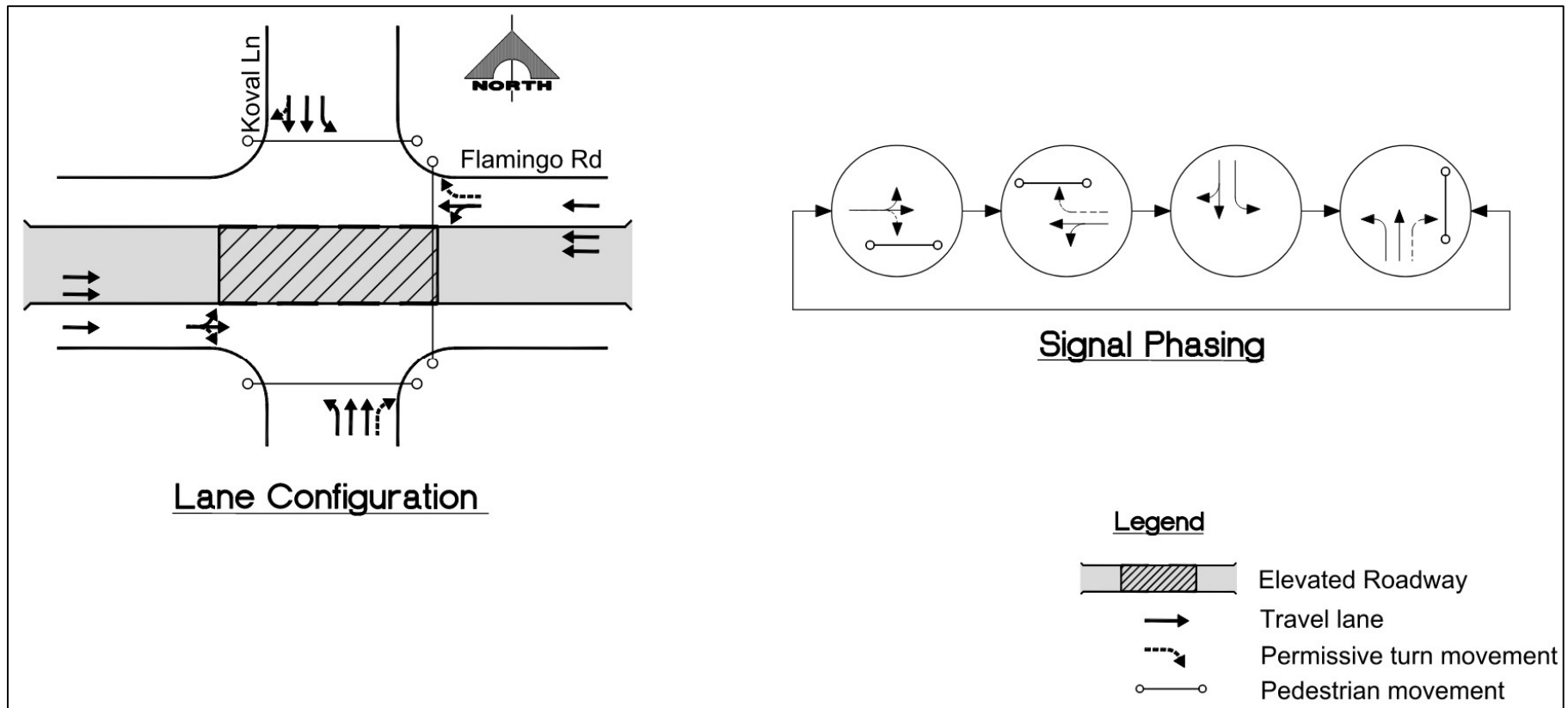

Figure 4. 2023 Temporary Bridge F1 Configuration and Traffic Signal Phasing



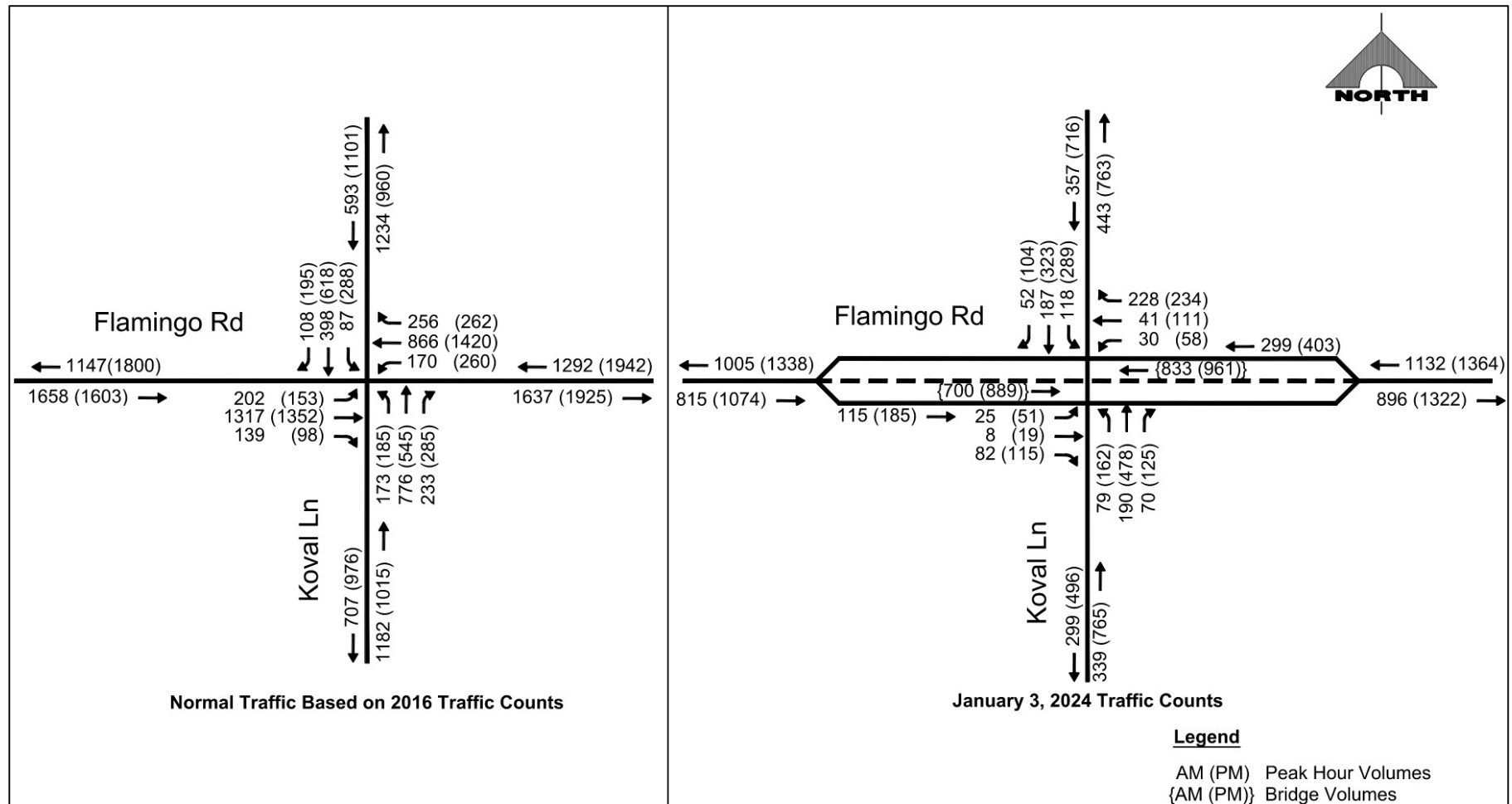

Figure 5. Normal Intersection Peak Hour Traffic Volumes and Peak Hour Traffic Volumes with F1 Configuration Temporary Bridge In Place

- With the temporary bridge in place, Koval Lane through traffic was 68% lower in the AM peak hour and 31% lower in the PM peak hour than normal.
- With the temporary bridge in place, turning movements between Flamingo Road and Koval Lane were 50% lower than normal in the AM peak hour and 34% lower than normal in the PM peak hour.

During the AM peak period, without a temporary bridge, the Flamingo Road/Koval Lane intersection typically operates at Level-of-Service D, serving approximately 4,725 vehicles per hour with an average delay of 40.6 seconds. During the PM peak period, without a temporary bridge, the Flamingo Road/Koval Lane intersection normally operates at Level-of-Service D, serving approximately 5,661 vehicles per hour with an average delay of 44.1 seconds.

With the temporary bridge in the F1 Configuration, the Flamingo Road/Koval Lane intersection, at-grade beneath the bridge, operated at Level-of-Service E during the AM peak period, but only served 1,110 vehicles per hour with an average delay of 77.6 seconds, and operated at Level-of-Service F during the PM peak period, but only served 2,069 vehicles per hour with an average delay of 85.9 seconds. Due to the inferior Level-of-Service of the at-grade intersection below the temporary bridge and physical capacity constraints, an estimated 1,481 vehicles in the AM peak hour and 601 vehicles in the PM peak hour that normally use Koval Lane appear to have diverted to other routes while the bridge was in place.

It is not entirely clear why east-west through traffic on Flamingo Road was so much lower than normal when counted on January 4, with a temporary bridge expediting through movements. It is possible that motorists who avoided the Flamingo Road corridor during F1 construction activities continued to avoid the Flamingo Road corridor through the holiday season.

Lower than normal traffic volumes on Koval Lane could be attributed to motorists selecting alternate routes to avoid delays at the reconfigured Flamingo Road/Koval Lane intersection, since the average delay in AM peak hour increased from 40.7 seconds under normal conditions to 77.6 seconds with the temporary bridge, and the average delay in the PM peak hour increased from 47.2 seconds under normal conditions to 85.9 seconds with the temporary bridge. Delays would have been even greater if a substantial volume of traffic normally using Koval Lane had not diverted to alternate routes.

Lower than normal turning movements at the Flamingo Road/Koval Lane intersection can be attributed to the physically constrained space that limits capacity.

It may be concluded that motorists who selected travel alternatives to Flamingo Road and Koval Lane during the F1 disruption, continued to use alternate routes the entire time that the temporary bridge was in place.

With the split-phase signal timing, four-phase traffic signal, and physical constraints with the temporary bridge layout, the following at-grade intersection operational problems were observed:



- Northbound and southbound Koval Lane was reduced from two left-turn lanes to a single left-turn lane onto westbound and eastbound Flamingo Road, respectively,
- Eastbound Flamingo Road approaching Koval Lane was reduced to a single lane serving through, left-turn, and right-turn traffic,
- Westbound Flamingo Road approaching Koval Lane was reduced from two left-turn lanes to one through/left-turn lane.
- Pedestrians could only cross with each through traffic signal phase, so that pedestrians had to queue on the corner for most of the 3-minute 46-second cycle waiting to cross, and then impeded right-turn vehicular movements on three of the four corners.

The most significant problem at the at-grade intersection involved pedestrians. Table 1 shows pedestrian counts which were taken at mid-day and early evening at the Flamingo Road/Koval Lane intersection crosswalks on January 4, 2024. An average of 386 pedestrians per hour crossed Koval Lane. This equates to an average of 24 pedestrians crossing Koval Lane on each cycle of the traffic signal. Eastbound Flamingo Road traffic approaching Koval Lane alongside the bridge had only one lane. Therefore, when the traffic signal for eastbound Flamingo Road was green, pedestrians crossing the south leg of the intersection blocked right-turning vehicles, and since there was only one eastbound lane, all eastbound traffic, including through, left-turns, and right-turns, were blocked until the pedestrians cleared the crosswalk.

**Table 1. Flamingo Road/Koval Lane Intersection Pedestrian Crossings Recorded on January 4, 2024**

Time of Day	North Crosswalk		South Crosswalk		Total
	WB	EB	WB	EB	WB
12:00 PM - 12:15 PM	19	18	29	18	84
12:15 PM - 12:30 PM	18	20	40	23	101
12:30 PM - 12:45 PM	6	11	16	31	64
12:45 PM - 1:00 PM	6	26	11	17	60
<b>Average Hourly</b>					
4:00 PM - 4:15 PM	9	31	36	38	114
4:15 PM - 4:30 PM	17	27	34	28	106
4:30 PM - 4:45 PM	25	26	53	53	157
4:45 PM - 5:00 PM	14	4	36	31	85
<b>Average Hourly</b>	<b>57</b>	<b>82</b>	<b>128</b>	<b>120</b>	<b>386</b>



### 3. IMPROVING THE OPERATION OF THE KOVAL LANE INTERSECTION WITH A TEMPORARY BRIDGE IN PLACE

Three alternatives for improving the operation of the Flamingo Road/Koval Lane intersection with a temporary bridge were evaluated:

- Alternative 1A: Improving the traffic signal phasing and timing of the temporary four-lane bridge.
- Alternative 1B: Improving the traffic signal phasing and timing operation and adding an eastbound right-turn lane of the temporary four-lane bridge.
- Alternative 1C: Improving the operation of the Koval Lane intersection with an eastbound two-lane temporary bridge and no westbound temporary bridge.

#### 3.1 Alternative 1A - Improving the Traffic Signal Operation of the At-Grade Intersection with F1 Temporary Four-Lane Bridge

In future years, if the F1 Configuration temporary bridge is installed for future races, and without changing the Flamingo Road/Koval Lane intersection lane configuration, the at-grade intersection of Koval Lane beneath the bridge could be substantially improved by reducing delays as follows (See Figure 6):

- Using lead-lag traffic signal phasing on Koval Lane, rather than split phasing,
- Optimizing splits, and
- Reducing the cycle length to 160 or 180 seconds.

With these traffic signal improvements, the normal Koval Lane traffic volume passing through the at-grade intersection of 2,585 vehicles in the AM peak hour and 3,019 vehicles in the PM peak hour could be accommodated through the at-grade intersection

with Level-of-Service E in the AM peak hour with an average delay of 62.2 seconds and with Level-of-Service E in the PM peak hour with an average delay of 79.3 seconds.

While some Koval Lane traffic would likely divert to alternate routes whenever the intersection Level-of-Service decreases to E, the at-grade intersection, with the temporary bridge in place, could accommodate more traffic on Koval Lane, with less delay, than with the current traffic signal phasing and timing.

#### 3.2 Alternative 1B - Improving the Traffic Signal Operation of the At-Grade Intersection and Adding an Eastbound Right-Turn Lane with F1 Temporary Four-Lane Bridge

In the AM peak hour, with the temporary bridge in place, the eastbound Flamingo Road traffic turning left onto northbound Koval Lane decreased by a factor of 10 as motorists found that movement was effectively blocked by right-turning vehicles stopping to allow pedestrian traffic to cross Koval Lane. In future years, if the F1 Configuration temporary bridge is installed for future races, the at-grade intersection of Koval Lane beneath the bridge could be significantly improved within existing right-of-way as follows (See Figure 7):

- Adding a right-turn lane from eastbound Flamingo Road to southbound Koval Lane along with right-turn phases on Flamingo Road that run concurrent with compatible left-turn phases on Koval Lane,
- Using lead-lag traffic signal phasing on Koval Lane, rather than split phasing,
- Optimizing splits, and
- Reducing the cycle length to 160 seconds.



With the minor reconfiguration to add a right-turn lane and traffic signal improvements, the normal traffic volume passing through the at-grade Koval Lane intersection of 2,585 vehicles in the AM peak hour and 3,019 vehicles in the PM peak hour could be accommodated through the at-grade intersection with Level-of-Service E in the AM peak hour with an average delay of 56.1 seconds and with Level-of-Service E in the PM peak hour with an average delay of 71.7 seconds.

While it is likely that some traffic would still divert to alternate routes whenever the intersection Level-of-Service decreases to E, the at-grade intersection with the addition of an eastbound right-turn lane when the temporary bridge is in place, could accommodate significantly more traffic on Koval Lane, with less delay, than with the 2023 F1 Configuration, traffic signal phasing, and timing.

### **3.3 Alternative 1C - Improving the Operation of the Koval Lane Intersection with an Eastbound Two-Lane Temporary Bridge and No Westbound Temporary Bridge**

For the 2023 F1 Race, the temporary bridge consisted of two separate two-lane structures, one structure for westbound Flamingo Road traffic over Koval Lane and a side-by-side parallel structure for eastbound Flamingo Road traffic over Koval Lane. This configuration allowed through traffic to cross over the bridge, in both directions, during the entire period when the bridges were in-place and operational.

An alternative to constructing two structures would be to only construct the eastbound two-lane structure, carrying eastbound

Flamingo Road traffic over Koval Lane, and to not construct the westbound structure. With this alternative:

- The westbound lanes of Flamingo Road would remain at grade and would only be closed during the actual hours of the F1 Race, and
- During the F1 Race, the eastbound bridge would be closed to all but emergency traffic, in both directions.

Figure 8 and Figure 9 show a proposed layout for the Flamingo Road/Koval Lane intersection with a single, eastbound two-lane bridge. The proposed layout includes:

- A two-lane eastbound Flamingo Road Bridge over Koval Lane of the same size and configuration as the 2023 F1 configuration in the eastbound direction but shifted and skewed slightly to optimize the at-grade lane configuration.
- Three at-grade westbound general-purpose travel lanes for Flamingo Road, plus one dedicated left-turn lane from westbound Flamingo Road to southbound Koval Lane.
- Two grade-separated eastbound general-purpose travel lanes, one at-grade eastbound general-purpose travel lane, plus one dedicated left-turn lane from eastbound Flamingo Road to NB Koval Lane and one dedicated right-turn lane from eastbound Flamingo Road to southbound Koval Lane.
- Koval Lane would not be reconfigured, although the southbound Koval Lane to eastbound Flamingo Road dual left-turns would be reduced to a single left-turn lane.



With the proposed configuration of this alternative, the bridge structure would be aligned with the two existing inside eastbound lanes for Flamingo Road. The at-grade eastbound through and right-turn lanes would align with the existing outside lane for Flamingo Road on the south side of the bridge, and the dedicated left-turn lane would occupy a left-turn pocket on the north side of the bridge.

While the eastbound temporary bridge is in-place, the only operational differences relative to the existing at-grade intersection would be:

- The north, west and east legs of the intersection would operate with single left-turn lanes instead of dual left-turn lanes, and
- The east leg of the intersection would not have a dedicated right-turn lane from WB Flamingo Road to NB Koval Lane.

With this alternative, the normal traffic volumes passing through the at-grade Koval Lane intersection of 3,416 vehicles in the AM peak hour and 4,328 vehicles in the PM peak hour could be accommodated at Level-of-Service D in the AM peak hour (with an average delay of 52.8 seconds) and at Level-of-Service E in the PM peak hour (with an average delay of 66.4 seconds).

With Alternative 1C, the average vehicle delay would be lower than the F1 Configuration, Alternatives 1A, and Alternative 1B, and it is less likely that motorists would select alternate routes.



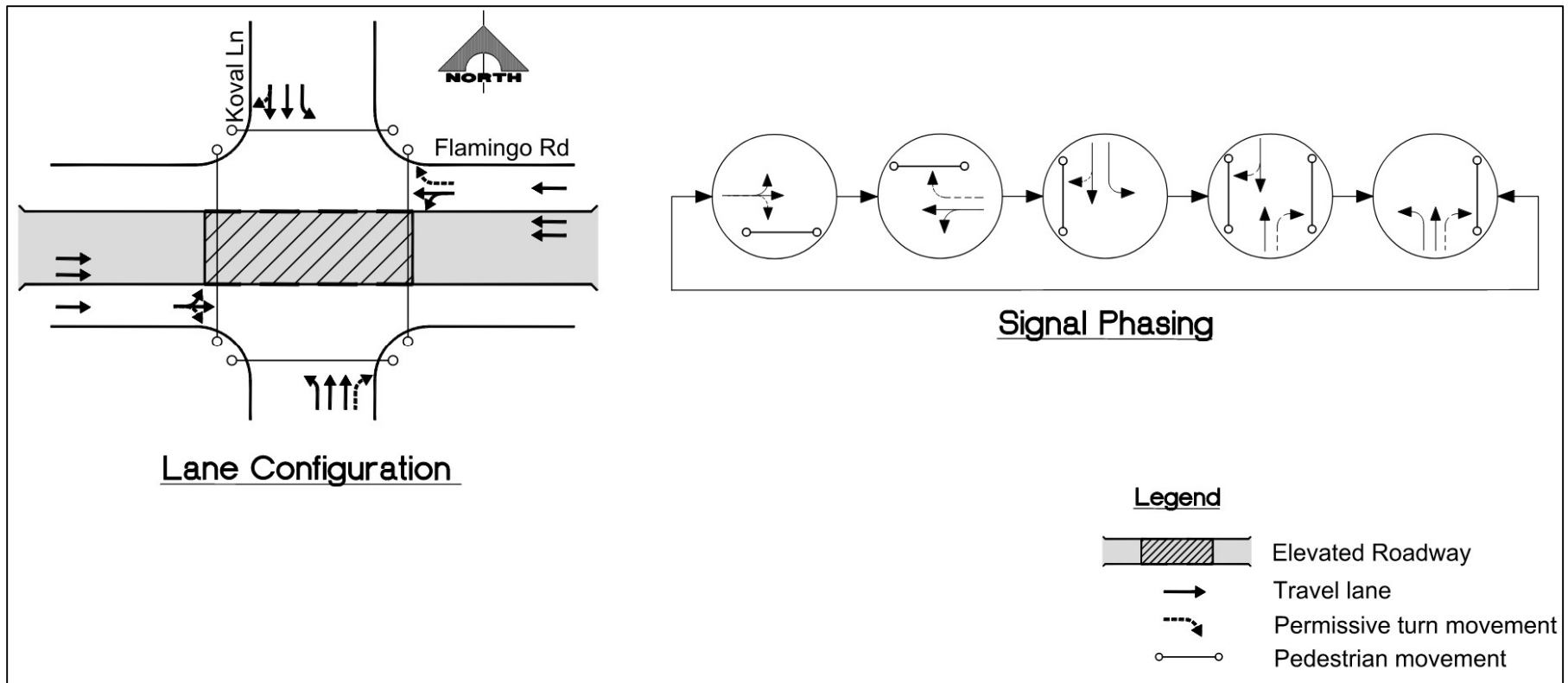
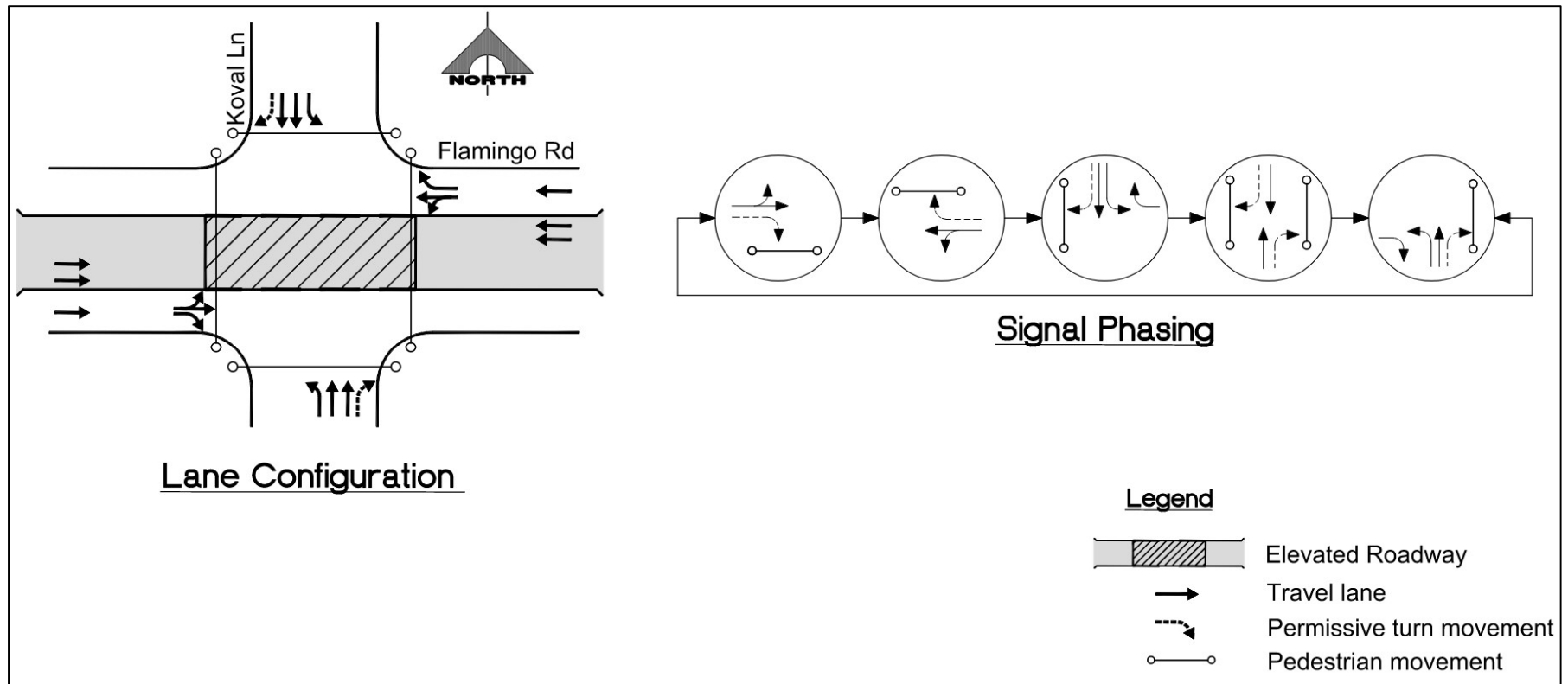

Figure 6. Alternative 1A – Temporary Bridge Lane Configuration with Improved Traffic Signal Phasing



**Figure 7. Alternative 1B – Temporary Bridge Lane Configuration with Improved Traffic Signal Phasing and Added EB Right-Turn Lane**



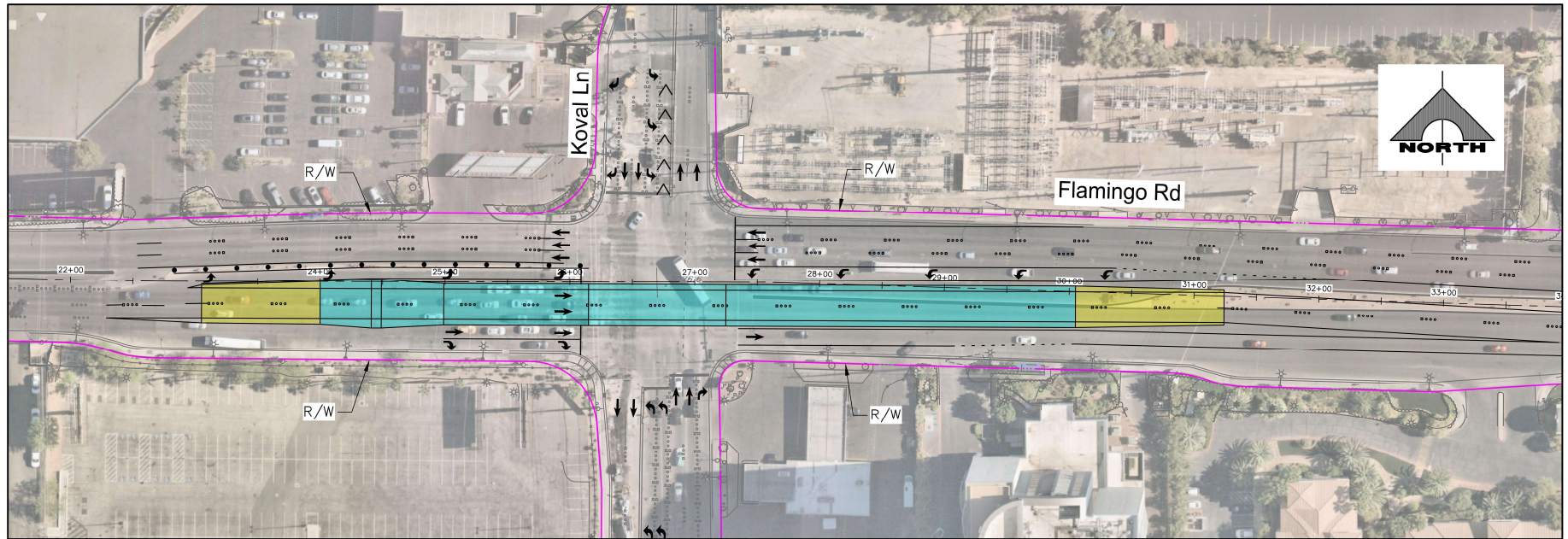

Figure 8. Alternative 1C – Temporary Eastbound Two-Lane Bridge

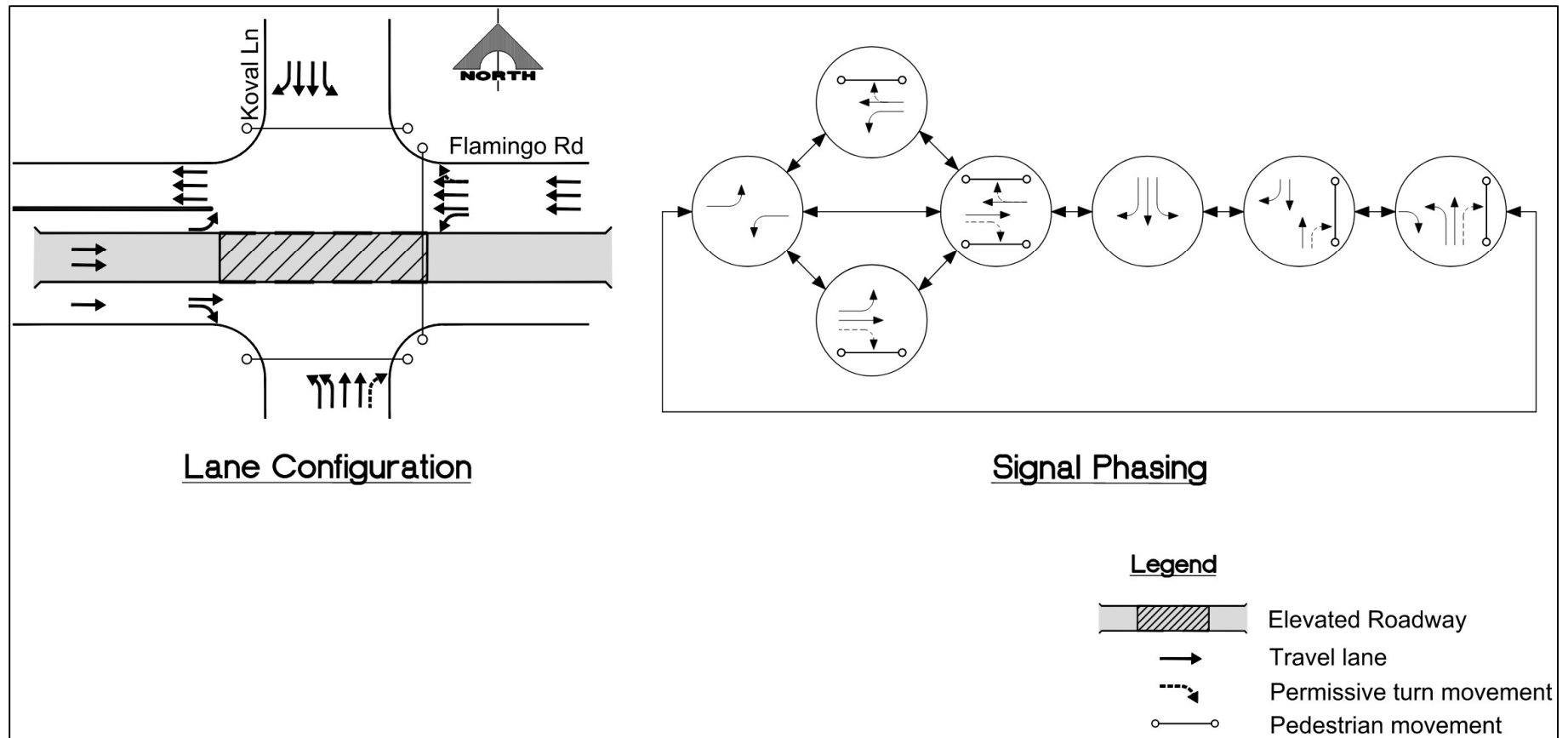

Figure 9. Alternative 1C – Temporary Eastbound Two-Lane Bridge Lane Configuration and Traffic Signal Phasing

#### **4. ALTERNATIVE 2 - IMPROVING THE OPERATION OF THE KOVAL LANE INTERSECTION WITH A PERMANENT FOUR-LANE BRIDGE**

A permanent bridge was evaluated as an alternative to recurring use of a temporary bridge and the associated traffic impacts of re-erecting and disassembling the bridge every year. A permanent bridge carrying Flamingo Road over Koval Lane would serve the same purpose as a temporary bridge plus:

- Provide travel time benefits year-round, and
- Provide travel time benefits beyond the projected 9 years when the temporary bridge may be employed.

If a permanent bridge were constructed, it would logically be constructed with a structure wide enough to carry four lanes of Flamingo Road traffic, two lanes in each direction, over Koval Lane, and with an at-grade intersection beneath the bridge configured to best accommodate at-grade movements, with improved traffic signal phasing and timing. Compared to the 2023 F1 Configuration at-grade intersection beneath the bridge, minor physical improvements would be desirable to:

- Add a right-turn lane from eastbound Flamingo Road to southbound Koval Lane, and
- Restore the second left-turn lane from southbound Koval Lane to eastbound Flamingo Road.

Adding these minor intersection improvements and traffic signal improvements, as shown in Figure 10, to a permanent bridge option, the normal traffic volume passing through the at-grade

Koval Lane Intersection of 2,585 vehicles in the AM peak hour and 3,019 vehicles in the PM peak hour could be accommodated through the at-grade intersection with Level-of-Service D in the AM peak hour and an average delay of 54.5 seconds and with Level-of-Service E in the PM peak hour and an average delay of 63.9 seconds.

As with the temporary bridge, traffic on Flamingo Road traveling over Koval Lane would be unimpeded and not experience any delays. Koval Lane traffic passing through the at-grade intersection beneath the bridge would experience somewhat higher delays than with the existing conditions without a bridge, but substantially lower delays than with the 2023 F1 temporary bridge configuration.



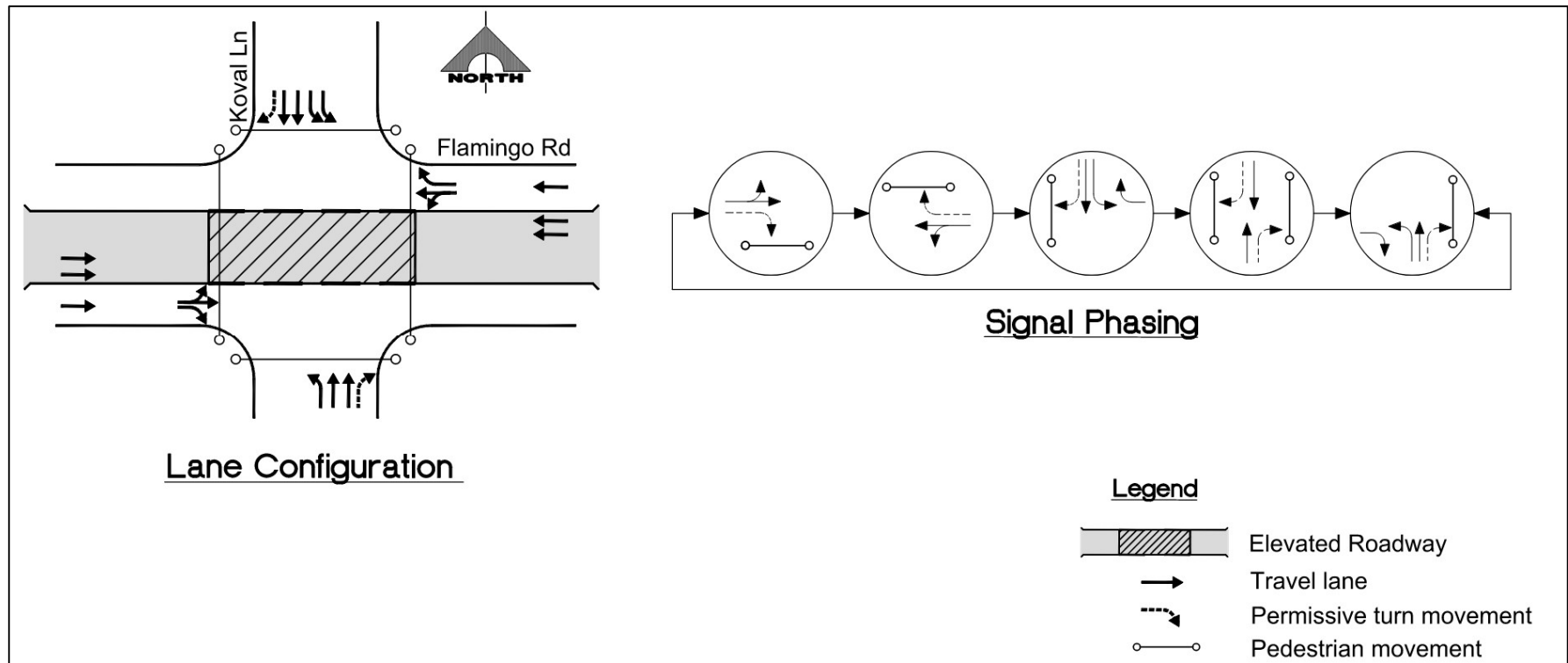

Figure 10. Alternative 2 – Permanent Bridge Lane Configuration and Traffic Signal Phasing

## 5. COMPARISON OF THE FLAMINGO ROAD/KOVAL LANE INTERSECTION OPERATIONS WITH AND WITHOUT A BRIDGE

Table 2 summarizes the travel time delays for the alternatives discussed above. With the normal operation of the Flamingo Road/Koval Lane intersection, without a bridge, with traffic volumes ranging from 4,725 vehicles in the AM peak hour to 5,661 vehicles in the PM peak hour, and with the intersection operating at Level-of-Service D, the total delay through the intersection experienced by motorists is estimated to be 917 hours per day. This value can be used as a basis for comparison.

If the normal traffic that passes through the Flamingo Road/Koval Lane intersection were to continue to pass through the intersection with a temporary bridge in place and with the 2023 F1 Configuration and traffic signal phasing and timing, then:

- 2,134 vehicles in the AM peak hour and 2,642 vehicles in the PM peak hour would use the Flamingo Road bridge to cross over Koval Lane without delay,
- 2,591 vehicles in the AM peak hour and 3,019 vehicles in the PM peak hour would pass through the at-grade intersection beneath the bridge, with the at-grade intersection operating at Level-of-Service F and with average delays during peak periods exceeding 100 seconds, and
- Total delay through the intersection experienced by motorists would be an estimated 1,212 hours per day.

These latter two bullets explain why 57% of the normal AM peak hour traffic and 31% of the normal PM peak hour traffic on Koval Lane elected to use alternate routes while the temporary bridge was in place.

With the temporary bridge in place, with the 2023 F1 Configuration and traffic signal phasing and timing, only 1,110 vehicles in the AM peak hour and 2,069 vehicles in the PM peak hour passed through the at-grade intersection beneath the bridge. This relatively small volume of traffic experienced an estimated total delay of only 455 hours per day. However, an estimated 1,481 vehicles in the AM peak hour and 950 vehicles in the PM peak hour used alternate routes to their destinations. By avoiding Koval Lane, vehicles using alternate routes likely experienced roughly 750 hours per day of additional travel time, assuming that the additional travel time was about equal to the intersection delay avoided.

Accordingly, with the 2023 F1 temporary bridge in place, motorists experienced an estimated additional travel time of 295 hours per day compared to normal operations. This should be considered as a net disbenefit experienced by motorists. In other words, travel time savings for motorists using Flamingo Road to cross unimpeded over Koval Lane were not sufficient to offset the increased delays for motorists on Koval Lane plus the added travel time for motorists avoiding Koval Lane by using alternate routes.

By improving the at-grade intersection traffic signal phasing and timing with a temporary bridge in place (Alternative 1A), it should be possible to reduce the total delay through the interchange by an estimated 137 hours per day compared to normal operations without a bridge, in which case the temporary bridge would provide net travel time benefits when in operation.



**Table 2. Flamingo Road/Koval Lane Intersection  
Operation of the Intersection With and Without a Flamingo Road Bridge over Koval Lane**

Scenario	At-Grade Peak Hour Traffic Volume		Bridge Peak Hour Traffic Volume		Level-of-Service		Average Delay for At-Grade Traffic (seconds)		Total Peak Hour Intersection Delay (hours)		Volume of Diverted Traffic		Total Daily Delay (hours)	Reduction in Daily Delay (hours)
	AM	PM	AM	PM	AM	PM	AM	PM	AM	PM	AM	PM		
Normal Operation without a Bridge	4,725	5,661	0	0	D	D	40.7	47.2	53.4	74.3	-	-	917	-
F1 Configuration Temporary Bridge with Normal Traffic	2,591	3,019	2,134	2,642	F	F	100.4	108.3	72.3	90.8	-	-	1,212	(295)
F1 Configuration Temporary Bridge (counted Jan. 4, 2024)	1,110	2,069	1,533	1,850	E	F	77.6	85.9	23.9	49.3	2,082	1,742	455	462
Alt. 1A - Temporary Bridge with Improved Signal Timing/Phasing	2,585	3,019	2,140	2,642	E	E	62.2	79.3	44.7	66.5	-	-	780	137
Alt. 1B - Temporary Bridge with Improved Signal & Added EB Right-Turn Lane	2,585	3,019	2,140	2,642	E	E	56.1	71.7	40.3	60.1	-	-	704	213
Alt. 1C – Temporary EB Two-Lane Bridge	3,416	4,328	1,309	1,333	D	E	52.8	66.4	50.1	79.8	-	-	896	21
Alt. 2 – Permanent Four-Lane Bridge	2,585	3,019	2,140	2,642	D	E	54.5	63.9	39.1	53.6	-	-	669	248



By improving the at-grade traffic signal phasing and timing and adding an eastbound Flamingo Road to southbound Koval Lane right-turn lane (Alternative 1B), with a temporary bridge in place, it should be possible to reduce the total delay through the intersection by an estimated 213 hours per day compared to normal operations without a bridge, providing even greater net travel time benefits.

By erecting only an eastbound temporary bridge (Alternative 1C), it should be possible to reduce the total delay through the intersection by an estimated 21 hours per day compared to normal operations without a bridge.

Alternative 1C, with only an eastbound temporary bridge, and with westbound Flamingo Road and with Koval Lane very close to their normal configuration, the average delays for vehicles and the total daily delay are nearly the same as experienced with normal operations without a bridge.

A permanent bridge (Alternative 2), incorporating improved traffic signal phasing and timing, and adding a right-turn lane from eastbound Flamingo Road to southbound Koval Lane and a second left-turn lane from southbound Koval Lane to eastbound Flamingo Road, would reduce total delay by an estimated 248 hours per day compared to normal operations, also providing greater net travel time benefits.

## 6. TRAFFIC DISRUPTION DURING THE ERECTION AND DISMANTLING OF THE TEMPORARY BRIDGE

Each year that the temporary bridge is erected for Flamingo Road over Koval Lane, Flamingo Road is closed for 11 consecutive days for the erection, including the entire closure of the Flamingo Road/Koval Lane intersection for 5 consecutive days. A similar time period for closure is required to dismantle the bridge. Therefore, if the bridge is erected for the F1 Race every year, then Flamingo Road would be closed for 22 days each year, and Koval Lane would be closed for 10 days each year.

The closure of a major arterial street causes a regional redistribution of traffic as motorists adjust to congestion by using alternate routes. The RTC's Year 2025 TransCAD traffic forecasting model was used to estimate the potential additional miles of travel and additional hours of travel that would be experienced by motorists as a result of the temporary closure of Flamingo Road.

Flamingo Road carries approximately 55,000 vehicles per day on a typical day. The closure of Flamingo Road for the erection of an F1 Configuration two-way temporary bridge results in an estimated 27,000 additional vehicle miles of travel per day and an estimated 1,900 vehicle hours of travel per day. Koval Lane carries approximately 28,000 vehicles per day on a typical day. The closure of Koval Lane for the erection of a temporary bridge results in an estimated 14,000 additional vehicle miles of travel per day and an estimated 950 vehicle hours of travel per day. These additional vehicle miles and vehicle hours of travel should be considered as a disbenefit that would occur each time that the F1 Configuration temporary bridge is erected or disassembled and



would more than offset any estimated travel time savings during the operation of the temporary bridge.

With Alternative 1C, westbound Flamingo Road could remain open to traffic during the entire period of erection and dismantling of the eastbound bridge. Maintaining westbound traffic would reduce traffic diverted from Flamingo Road during closures by half, with an estimated 13,500 additional vehicle miles of travel per day and an estimated 950 vehicle hours of travel per day. However, because only the eastbound temporary bridge would be constructed, the closure period for Flamingo Road would be reduced to approximately 7 days for erection and 7 days for dismantling, for a total Flamingo Road closure of 14 days, and for eastbound Flamingo Road only. As with the other temporary bridge alternatives, Koval Lane would be closed for an estimated 10 days during erection and dismantling of the bridge resulting in an estimated 14,000 additional miles of travel per day and an estimated 950 additional hours of travel per day.

## **7. TRAFFIC DISRUPTION DURING THE CONSTRUCTION OF A PERMANENT FOUR-LANE BRIDGE**

The construction of a permanent bridge for Flamingo Road over Koval Lane would take approximately 1 year to construct and open to traffic. Given the time for planning and design, the soonest a permanent bridge could be constructed and opened would be prior to the November 2027 F1 race.

It would not be practical to have a full closure of Flamingo Road during the 1-year construction. Therefore, a construction method must be used that maintains some travel lanes open on Flamingo Road during construction. The RTC's Year 2025 TransCAD traffic

forecasting model was used to estimate the potential additional miles of travel and additional hours of travel that would be experienced by the public as a result of lane reductions on Flamingo Road.

The reduction of lanes on Flamingo Road during permanent bridge construction would result in an estimated 200 additional vehicle miles of travel per day and an estimated additional 700 vehicle hours of travel per day. The increase in travel time during construction could be significant, with daily delays of about 25% of a full closure but extended over an entire year. These additional vehicle miles and vehicle hours of travel should be considered as a disbenefit that would occur for one extended period, while the permanent bridge is under construction, and would partially offset any estimated travel time savings over the life of the permanent bridge.

## **8. ESTIMATED TRAVEL TIME BENEFITS (DISBENEFITS)**

To estimate the cost of travel time savings, the following factors were used:

- U.S. Bureau of Labor Statistics Las Vegas/Paradise average wage rate of \$26.16/hour.
- U.S. Department of Transportation Bureau of Transportation Statistics average vehicle operation cost of \$0.72/mile.
- Vehicle occupancy of 1.1 persons/vehicle.
- Present worth factor based on 3% inflation.
- A temporary bridge requires 11 days for erection, operates for 30 days, and then requires 11 days for dismantling.
- A permanent bridge requires one year for construction.





### 8.1 Estimated Travel Time Benefits (Disbenefits) of a Temporary Bridge

Table 3 shows the estimated net present value of erecting, operating, and dismantling a temporary bridge annually for 9 years, from 2024 through 2032, with 2023 F1 Configuration, traffic signal phasing and timing. During the 30 days of the temporary bridge operation, an estimated 295 additional hours of travel time per day for delayed and diverted traffic would result in estimated additional travel time costs of \$8,493 each day. During erection and dismantling of the bridge, traffic diversions of Flamingo Road during closures would add 27,000 miles of travel and 1,900 hours of travel per day for 22 days and traffic diversions of Koval Lane during closures would add 14,000 miles of travel and 950 hours of travel per day for 10 days and would result in estimated additional travel costs of \$2 million each year. The additional travel costs should be considered as a disbenefit of the temporary bridge in the 2023 F1 Configuration, which would result in an estimated annual total cost to motorists of \$2.3 million each year that the temporary bridge is used, with a net present value of disbenefits over the potential 9 years that a temporary bridge could be employed that is equivalent to a \$18.2 million loss to motorists.

Table 4 shows the estimated net present value of erecting, operating, and dismantling a temporary bridge annually for 9 years, from 2024 through 2032, with Alternative 1A - Improved traffic signal phasing and timing of the at-grade intersection. By improving the traffic signal phasing and timing, during the 30 days of operation of the temporary bridge, an estimated 432 hours of travel time per day could be saved compared to the 2023 F1 Configuration, traffic signal phasing and timing. Compared to the

existing at-grade Flamingo Road/Koval Lane intersection, an estimated 137 fewer hours of travel time would result in estimated travel time savings of \$3,934 per day for 30 days. However, these savings are still offset by the estimated additional travel costs of \$2 million for closures of Flamingo Road and Koval Lane each year during the erection and dismantling of the temporary bridge. By improving the traffic signal phasing and timing for the temporary bridge, there would be significant travel time savings compared to the 2023 F1 Configuration of the at-grade intersection. Accordingly, the estimated cost to motorists of the temporary bridge could be reduced to \$1.9 million each year that the temporary bridge is used, with a net present value of disbenefits over the potential 9 years that a temporary bridge could be employed that is equivalent to a \$15.2 million loss to motorists. This is \$3 million better than for the 2023 F1 Configuration.

Table 5 shows the estimated net present value of erecting, operating, and dismantling a temporary bridge annually for 9 years, from 2024 through 2032, with Alternative 1B - Improved traffic signal phasing and timing of the at-grade intersection and the addition of an eastbound Flamingo Road to southbound Koval Lane right-turn lane. By improving the traffic signal phasing and timing and adding the right-turn lane, during the 30 days of operation of the temporary bridge, an estimated 508 hours of travel time per day could be saved compared to the 2023 F1 Configuration, traffic signal phasing and timing. Compared to the existing at-grade Flamingo Road/Koval Lane intersection, an estimated 213 fewer hours of travel time would result in estimated travel time savings of \$6,131 per day for 30 days. However, again, these savings are offset by the estimated



additional travel costs of \$2 million each year during the erection and dismantling of the temporary bridge. By improving the traffic signal phasing and timing and adding a right-turn lane, there would be even greater travel time savings compared to the F1 Configuration at-grade intersection. Accordingly, the estimated cost to motorists of the temporary bridge could be reduced to \$1.8 million each year that the temporary bridge is used, with a net present value of disbenefits over the potential 9 years that a temporary bridge could be employed that is equivalent to a \$14.6 million loss to motorists. This is \$3.5 million better than for the 2023 F1 Configuration.

Table 6 shows the estimated net present value of erecting, operating, and dismantling a single eastbound temporary structure (Alternative 1C) annually for 9 years, from 2024 through 2032. During the 30 days of the eastbound temporary bridge operation, an estimated 316 hours of travel time per day could be saved compared to the 2023 F1 Configuration. Compared to the existing at-grade Flamingo Road/Koval Lane intersection, an estimated 21 fewer hours of travel time would result in estimated travel time savings of \$601 per day for 30 days. Since only the eastbound lanes of Flamingo Road would be closed during the erection and dismantling of the eastbound temporary bridge, and only for 14 days, the travel costs for closures of eastbound Flamingo Road and Koval Lane would be reduced to about \$750,000 annually, still more than offsetting the minor travel time savings during operation of the eastbound temporary bridge. The net present value of disbenefits over the potential 9 years that an eastbound temporary bridge could be employed is estimated to be \$5.9 million. Therefore, the net present value of the disbenefits of an eastbound temporary bridge is much lower

than any of the other temporary bridge alternatives with bridges in both directions, and \$12.2 million better than for the 2023 F1 Configuration.

## 8.2 Estimated Travel Time Benefits (Disbenefits) of a Permanent Four-Lane Bridge

Table 7 shows the estimated net present value of constructing and operating a permanent bridge, providing two grade-separated lanes in each direction for Flamingo Road over Koval Lane, with an at-grade intersection under the bridge with improved traffic signal phasing and timing, the addition of an eastbound Flamingo Road to southbound Koval Lane right-turn lane and the addition of a second left-turn lane from southbound Koval Lane to eastbound Flamingo Road. With these improvements, an estimated 543 hours of travel time per day could be saved compared to the F1 Configuration traffic signal phasing and timing. Compared to the existing at-grade Flamingo/Koval intersection, an estimated 248 fewer hours of travel time would result in estimated travel time savings of \$7,137 per day. Because the bridge would be permanent, the travel time savings would occur 365 days per year for the life of the bridge.



**Table 3. Estimated Travel Time Benefits (Disbenefits) of the F1 Configuration Temporary Bridge**

Year	Daily Travel Time Savings	Annual Travel Times Savings	Closure Costs (22 days)	Present Worth of Benefits (Disbenefits)
2024	\$(8,493)	\$(254,790)	\$(2,008,930)	\$(2,263,720)
2025	\$(8,493)	\$(254,790)	\$(2,008,930)	\$(2,197,787)
2026	\$(8,493)	\$(254,790)	\$(2,008,930)	\$(2,133,773)
2027	\$(8,493)	\$(254,790)	\$(2,008,930)	\$(2,071,625)
2028	\$(8,493)	\$(254,790)	\$(2,008,930)	\$(2,011,286)
2029	\$(8,493)	\$(254,790)	\$(2,008,930)	\$(1,952,705)
2030	\$(8,493)	\$(254,790)	\$(2,008,930)	\$(1,895,830)
2031	\$(8,493)	\$(254,790)	\$(2,008,930)	\$(1,840,612)
2032	\$(8,493)	\$(254,790)	\$(2,008,930)	\$(1,787,002)

**Total Net Present Value of Travel Time Benefits/(Disbenefits) = \$(18,154,399)**

**Table 4. Estimated Travel Time Benefits (Disbenefits) of Alternative 1A - Temporary Bridge With Traffic Signal Improvements**

Year	Daily Travel Time Savings	Annual Travel Times Savings	Closure Costs (22 days)	Present Worth of Benefits (Disbenefits)
2024	\$3,934	\$118,020	\$(2,008,930)	\$(1,890,910)
2025	\$3,934	\$118,020	\$(2,008,930)	\$(1,835,835)
2026	\$3,934	\$118,020	\$(2,008,930)	\$(1,782,364)
2027	\$3,934	\$118,020	\$(2,008,930)	\$(1,730,451)
2028	\$3,934	\$118,020	\$(2,008,930)	\$(1,680,049)
2029	\$3,934	\$118,020	\$(2,008,930)	\$(1,631,116)
2030	\$3,934	\$118,020	\$(2,008,930)	\$(1,583,607)
2031	\$3,934	\$118,020	\$(2,008,930)	\$(1,537,483)
2032	\$3,934	\$118,020	\$(2,008,930)	\$(1,492,702)

**Alternative 1A - Total Net Present Value of Travel Time Benefits/(Disbenefits) = \$(15,164,517)**



**Table 5. Estimated Travel Time Benefits (Disbenefits) of Alternative 1B - Temporary Bridge With Traffic Signal Improvements and Added EB Right-Turn Lane**

Year	Daily Travel Time Savings	Annual Travel Times Savings	Closure Costs (22 days)	Present Worth of Benefits (Disbenefits)
2024	\$6,131	\$183,930	\$(2,008,930)	\$(1,825,000)
2025	\$6,131	\$183,930	\$(2,008,930)	\$(1,771,845)
2026	\$6,131	\$183,930	\$(2,008,930)	\$(1,720,238)
2027	\$6,131	\$183,930	\$(2,008,930)	\$(1,670,134)
2028	\$6,131	\$183,930	\$(2,008,930)	\$(1,621,489)
2029	\$6,131	\$183,930	\$(2,008,930)	\$(1,574,261)
2030	\$6,131	\$183,930	\$(2,008,930)	\$(1,528,409)
2031	\$6,131	\$183,930	\$(2,008,930)	\$(1,483,892)
2032	\$6,131	\$183,930	\$(2,008,930)	\$(1,440,672)

**Alternative 1B - Total Net Present Value of Travel Time Benefits/(Disbenefits) = \$(14,635,939)**

**Table 6. Estimated Travel Time Benefits (Disbenefits) of Alternative 1C – Temporary Two-Lane Eastbound Bridge**

Year	Daily Travel Time Savings	Annual Travel Times Savings	Closure Costs (22 days)	Present Worth of Benefits (Disbenefits)
2024	\$601	\$18,030	\$(755,924)	\$(737,894)
2025	\$601	\$18,030	\$(755,924)	\$(716,402)
2026	\$601	\$18,030	\$(755,924)	\$(695,536)
2027	\$601	\$18,030	\$(755,924)	\$(675,278)
2028	\$601	\$18,030	\$(755,924)	\$(655,609)
2029	\$601	\$18,030	\$(755,924)	\$(636,514)
2030	\$601	\$18,030	\$(755,924)	\$(617,975)
2031	\$601	\$18,030	\$(755,924)	\$(599,975)
2032	\$601	\$18,030	\$(755,924)	\$(582,500)

**Alternative 1C - Total Net Present Value of Travel Time Benefits/(Disbenefits) = \$(5,917,683)**



**Table 7. Estimated Travel Time Benefits (Disbenefits) of Alternative 2 – Permanent Four-Lane Bridge**

Year	Daily Travel Time Savings	Annual Travel Times Savings	Closure Costs (12 months)	Present Worth of Benefits (Disbenefits)
2024				
2025				
2026			\$(7,568,669)	\$(7,134,197)
2027	\$7,137	\$2,605,005	\$0	\$2,390,480
2028	\$7,137	\$2,605,005	\$0	\$2,320,854
2029	\$7,137	\$2,605,005	\$0	\$2,253,257
2030	\$7,137	\$2,605,005	\$0	\$2,187,628
2031	\$7,137	\$2,605,005	\$0	\$2,123,910
2032	\$7,137	\$2,605,005	\$0	\$2,062,049
2033	\$7,137	\$2,605,005	\$0	\$2,001,989
2034	\$7,137	\$2,605,005	\$0	\$1,943,679
2035	\$7,137	\$2,605,005	\$0	\$1,887,067
2036	\$7,137	\$2,605,005	\$0	\$1,832,104
2037	\$7,137	\$2,605,005	\$0	\$1,778,742
2038	\$7,137	\$2,605,005	\$0	\$1,726,934
2039	\$7,137	\$2,605,005	\$0	\$1,676,635
2040	\$7,137	\$2,605,005	\$0	\$1,627,801
2041	\$7,137	\$2,605,005	\$0	\$1,580,389
2042	\$7,137	\$2,605,005	\$0	\$1,534,358
2043	\$7,137	\$2,605,005	\$0	\$1,489,668
2044	\$7,137	\$2,605,005	\$0	\$1,446,280
2045	\$7,137	\$2,605,005	\$0	\$1,404,155
2046	\$7,137	\$2,605,005	\$0	\$1,363,257

**Alternative 2 -Permanent Bridge- Total Net Present Value of Travel Time Benefits/(Disbenefits) = \$29,497,038**

By maintaining some lanes of traffic for Flamingo Road open during the construction of a permanent bridge, daily travel delays during construction would be reduced compared to the closures with the temporary bridge but would still result in an estimated 716 hours per day of additional travel time for motorists for the estimated one-year construction period. This would result in estimated additional travel costs to motorists of \$7,568,699 during the one-year construction period. This one-time cost of \$7.6 million can be compared to the recurring \$1.9 million annual cost of closures for the erection and dismantling of the temporary bridge. The net present value of the benefits to motorists of a permanent bridge is estimated to be \$29.5 million based on a 20-year economic life.

For comparison purposes, the estimated travel time benefits of a permanent bridge only carrying two eastbound lanes of Flamingo Road over Koval Lane was evaluated. This eastbound permanent bridge configuration would be similar to the eastbound temporary bridge with Alternative 1C. Compared to the existing at-grade Flamingo/Koval intersection, an estimated 65 fewer hours of travel time per day would result in estimated travel time savings of \$1,858 per day, 365 days per year, for the 20-year life of the bridge.



By only constructing a permanent bridge in the eastbound direction, more lanes of Flamingo Road could remain open during construction, reducing the estimated additional travel time for motorists during construction to about 350 hours per day. This would result in estimated additional travel costs to motorists of \$3,700,000 during the one-year construction period. This one-time cost of \$3.7 million can be compared to the recurring \$750,000 annual cost of closures for the erection and dismantling of the temporary bridge with Alternative 1C.

As shown in Table 8, the net present value of the benefits to motorists of an eastbound permanent two-lane bridge is estimated to be only \$6 million based on a 20-year economic life. However, the construction cost for an eastbound permanent bridge would be on the order of \$20 million, so that the Benefit/Cost ratio would only be about 0.3, indicating that constructing a permanent bridge only carrying eastbound traffic for Flamingo Road over Koval Lane would not be viable.

**8.3 Comparison of Estimated Travel Time Benefits (Disbenefits) of Temporary Bridge vs. Permanent Bridge**

Table 9 summarizes and compares the net present values discussed above. The temporary bridge with the 2023 F1 Configuration, traffic signal phasing and timing does not create any net travel time savings. The travel time savings for traffic on Flamingo Road crossing unimpeded over Koval Lane without delay is more than offset by the at-grade intersection delays under the bridge plus the travel time losses of traffic diverted from Koval Lane and using alternate routes.

**Table 8. Estimated Travel Time Benefits (Disbenefits) of a Permanent Two-Lane Bridge (Eastbound Only)**

Year	Daily Travel Time Savings	Annual Travel Times Savings	Closure Costs (12 months)	Present Worth of Benefits (Disbenefits)
2024				
2025				
2026			\$(3,700,000)	\$(3,487,605)
2027	\$1,858	\$678,170	\$0	\$620,622
2028	\$1,858	\$678,170	\$0	\$602,545
2029	\$1,858	\$678,170	\$0	\$584,995
2030	\$1,858	\$678,170	\$0	\$567,957
2031	\$1,858	\$678,170	\$0	\$551,414
2032	\$1,858	\$678,170	\$0	\$535,354
2033	\$1,858	\$678,170	\$0	\$519,761
2034	\$1,858	\$678,170	\$0	\$504,622
2035	\$1,858	\$678,170	\$0	\$489,924
2036	\$1,858	\$678,170	\$0	\$475,655
2037	\$1,858	\$678,170	\$0	\$461,801
2038	\$1,858	\$678,170	\$0	\$448,350
2039	\$1,858	\$678,170	\$0	\$435,292
2040	\$1,858	\$678,170	\$0	\$422,613
2041	\$1,858	\$678,170	\$0	\$410,304
2042	\$1,858	\$678,170	\$0	\$398,353
2043	\$1,858	\$678,170	\$0	\$386,751
2044	\$1,858	\$678,170	\$0	\$375,486
2045	\$1,858	\$678,170	\$0	\$364,550
2046	\$1,858	\$678,170	\$0	\$353,932

**Permanent Two-Lane Bridge (Eastbound Only) - Total Net Present Value of Travel Time Benefits/(Disbenefits) = \$6,022,676**



If the configuration and traffic signal phasing and timing is improved, with Alternatives 1A or 1B, substantial travel time savings can be achieved during the operation of the temporary bridge. However, these travel time savings are insufficient to fully offset the travel time losses during the erection and dismantling of the temporary bridge. It may be concluded, therefore, that while the Flamingo Road/Koval Lane intersection with a 2023 F1 Configuration temporary bridge could be operated much better, the net present value of the two-way temporary bridge always results in a net loss for motorists.

If only an eastbound temporary bridge is constructed, travel times for vehicles passing through the Flamingo Road/Koval Lane intersection, with the temporary bridge in place, would be similar to those for the existing Flamingo Road/Koval Lane intersection. The time savings of the eastbound Flamingo Road traffic crossing over Koval Lane on the bridge would be offset with the increased delays on Koval Lane utilizing the at-grade intersections. Moreover, since losses in travel time during the closure of eastbound Flamingo Road and Koval Lane for the erection and dismantling of the EB temporary bridge would be much less than that of the temporary four-lane (two-way) bridge alternatives, disbenefits during closures would be much lower. Therefore, Alternative 1C would have the lowest level of disbenefits of all temporary bridge alternatives, and only one-third of the travel time losses experienced with the 2023 F1 Configuration.

As summarized in Table 9, despite substantial travel time losses during the construction of the permanent bridge, travel time savings over the life of the permanent bridge would be sufficient to provide a net present value of \$29.5 million. The estimated cost to construct a permanent bridge is \$28.0 million. Therefore, a permanent bridge to carry Flamingo Road over Koval Lane would have a Benefit/Cost Ratio of ( $\$29.5\text{M}/\$28.0\text{M} =$ ) 1.05 when compared with the existing Flamingo Road/Koval Lane.



**Table 9. Flamingo Road/Koval Lane Intersection  
Estimated Net Present Value of Travel Time Benefits (Disbenefits) Compared to  
Normal Operation without a Flamingo Road Bridge over Koval Lane**

Scenario	Time Duration	Annual Travel Time Savings (losses)	Annual Closure or Lane Reduction Costs	Net Present Value of Travel Time Savings
F1 Configuration Temporary Bridge	Annually for 9 years – 22-day closure and 30-day operation	(\$254,790)	(\$2,008,930)	(\$18,154,339*)
Alt. 1A - Temporary Bridge with Improved Signal Timing/Phasing	Annually for 9 years – 22-day closure and 30-day operation	\$118,020	(\$2,008,930)	(\$15,164,517*)
Alt 1B - Temporary Bridge with Improved & Added EB Right-Turn	Annually for 9 years – 22-day closure and 30-day operation	\$183,930	(\$2,008,930)	(\$14,635,939*)
Alt. 1C – Temporary EB Two-Lane Bridge	Annually for 9 years – 22-day closure and 30-day operation	\$18,030	(\$755,924)	(\$5,917,683*)
Alt. 2 - Permanent Four-Lane Bridge	Annually for 20 years – 1 year of lane reductions during construction and 365-day/year operation	\$2,605,005	(\$7,568,669)	\$29,497,038*

\*Losses do not include potential losses from reduced business activity





## 9. WIDENING OF KOVAL LANE TO SIX LANES

The Clark County Department of Public Works is planning to widen Koval Lane from four lanes to six lanes between Tropicana Avenue and Sands Avenue. This widening would provide capacity to accommodate additional traffic volume on Koval Lane. With Koval Lane widened to six lanes, the preliminary design for the widening of Koval Lane does not include additional lanes at the Flamingo Road/Koval Lane intersection. The preliminary design at the intersection, for a widened Koval lane, converts existing northbound and southbound right-turn pockets at the intersection to share through/right-turn lanes. Therefore, with Koval Lane widened to six lanes, without a bridge, the Flamingo Road/Koval Lane intersection would be expected to continue to operate with the same Level-of-Service D during peak hours as under current traffic conditions with average delays of approximately 40 seconds during the AM peak hour and 47 seconds during the PM peak hour, as well as to accommodate future increased traffic volumes.

However, while the existing intersection could accommodate additional traffic as a result of a widened Koval Lane, the at-grade intersection beneath a temporary bridge could not accommodate any increase in traffic volumes. During the operation of the temporary bridge, a substantial volume of traffic normally using Koval Lane elected to use alternate routes. The volume of traffic that normally uses Koval Lane, but drivers elected to use other routes while the temporary bridge was in place is estimated to be 1,481 vehicles in the AM peak hour and 601 vehicles in the PM peak hour. A widened Koval Lane could attract up to an additional 1,500 vehicles per hour during peak periods. However, due to the restricted capacity of the at-grade Flamingo Road/Koval Lane

intersection with a temporary bridge, the additional 1,500 vehicles per hour would likely be diverted to other routes while the temporary bridge is in operation. This volume of additional diverted traffic would temporarily (while the temporary bridge is in place) negate the benefits of widening Koval Lane.

With a permanent bridge, the proposed configuration of the intersection beneath the bridge includes sufficient space to accommodate one additional lane in each direction beneath the bridge.

## 10. TEMPORARY BRIDGE DESIGN OBSERVATIONS

The temporary Flamingo Road Bridge over Koval Lane constructed by the F1 organization was a metal structure with a total length of about 800 feet. This relatively short length allowed it to pass under the overhead electrical power lines east of Koval Lane and to maximize the distance for motorists to merge and diverge between the ends of the bridge and the adjacent intersections at Linq Lane and Howard Hughes Parkway. However, the relatively short length of the overpass was accompanied by short broken-back sections approximating vertical curves which reduced the effective design speed over the bridge to about 30 mph. The posted speed limit on Flamingo Road is 35 mph.

The temporary bridge spanned over Koval Lane with a single bent, allowing the two through lanes in each direction on Koval Lane to remain open to traffic. However, barrier rails and other safety devices for the temporary bridge narrowed the available width of Flamingo Road alongside the bridge to a single at-grade lane. The reduced at-grade lanes effectively served as ramps to carry



Flamingo Road traffic to and from Koval Lane, but restricted the volume of traffic which could move between Flamingo Road and Koval Lane.

Because the installation was temporary, minimal changes were made to the traffic signal system at the Flamingo Road/Koval Lane intersection. There was not adequate time to modify the existing traffic signal system prior to the F1 race and erection of the bridge. The modification of the traffic signal system to better accommodate the temporary at-grade lane configuration or the installation of a temporary overhead span wire traffic signal system, in addition to improved traffic signal timing and phasing could, in the future, improve the flow of at-grade traffic with a temporary bridge in place.

Accommodating pedestrians on Flamingo Road crossing Koval Lane will continue to be a problem with a temporary bridge unless additional space is made to add a dedicated right-turn lane from eastbound Flamingo Road to southbound Koval Lane, or a temporary pedestrian bridge is provided 24-hours/day, 7 days/week, for the entire period that the temporary bridge is in place, not just during the actual F1 Race.

## **11. PERMANENT FOUR-LANE BRIDGE CONCEPT**

Figure 11 shows a conceptual layout of a permanent four-lane bridge for Flamingo Road over Koval Lane. Figure 12 shows a conceptual cross-section for a permanent four-lane bridge and Figure 13 shows a conceptual cross section for an elevated approach for a permanent four-lane bridge.

As with the temporary bridge, a permanent bridge would carry two lanes in each direction of Flamingo Road traffic over Koval Lane. The conceptual plan layout and profile show a length of about 1,500 feet from touch-down to touch-down, starting about 800 feet west of Koval Lane and ending about 700 feet east of Koval Lane. This profile assumes that the Flamingo Road Bridge would be designed with a 45 mph design speed, so that through traffic on Flamingo Road would not have to slow going over Koval Lane. The posted speed limit on Flamingo Road is 35 mph.

The permanent bridge would span over the entire Koval Lane at-grade intersection with the eastbound and westbound bridge structures offset to facilitate truck turning movements under the bridge and the installation of crash attenuators at the corners of the structures. The proposed bridge structure would be constructed using steel girders or concrete I-girders to speed construction. Bridge approaches centered in Flamingo Road would be constructed with mechanically stabilized earth (MSE) retaining walls to speed construction and minimize the construction work zone.

The use of MSE retaining walls and standard concrete barrier rails, with 11-foot wide travel lanes on Flamingo Road, would allow two at-grade lanes to be constructed along the south side of the bridge to improve the flow of traffic from eastbound Flamingo Road to northbound Koval Lane, and from southbound Koval Lane to eastbound Flamingo Road. Compared to the temporary bridge, these additional lanes on Flamingo Road and the installation of a permanent traffic signal system for the at-grade intersection under the bridge would improve the flow of traffic on Koval Lane and for the turning movements between Flamingo Road and Koval Lane.



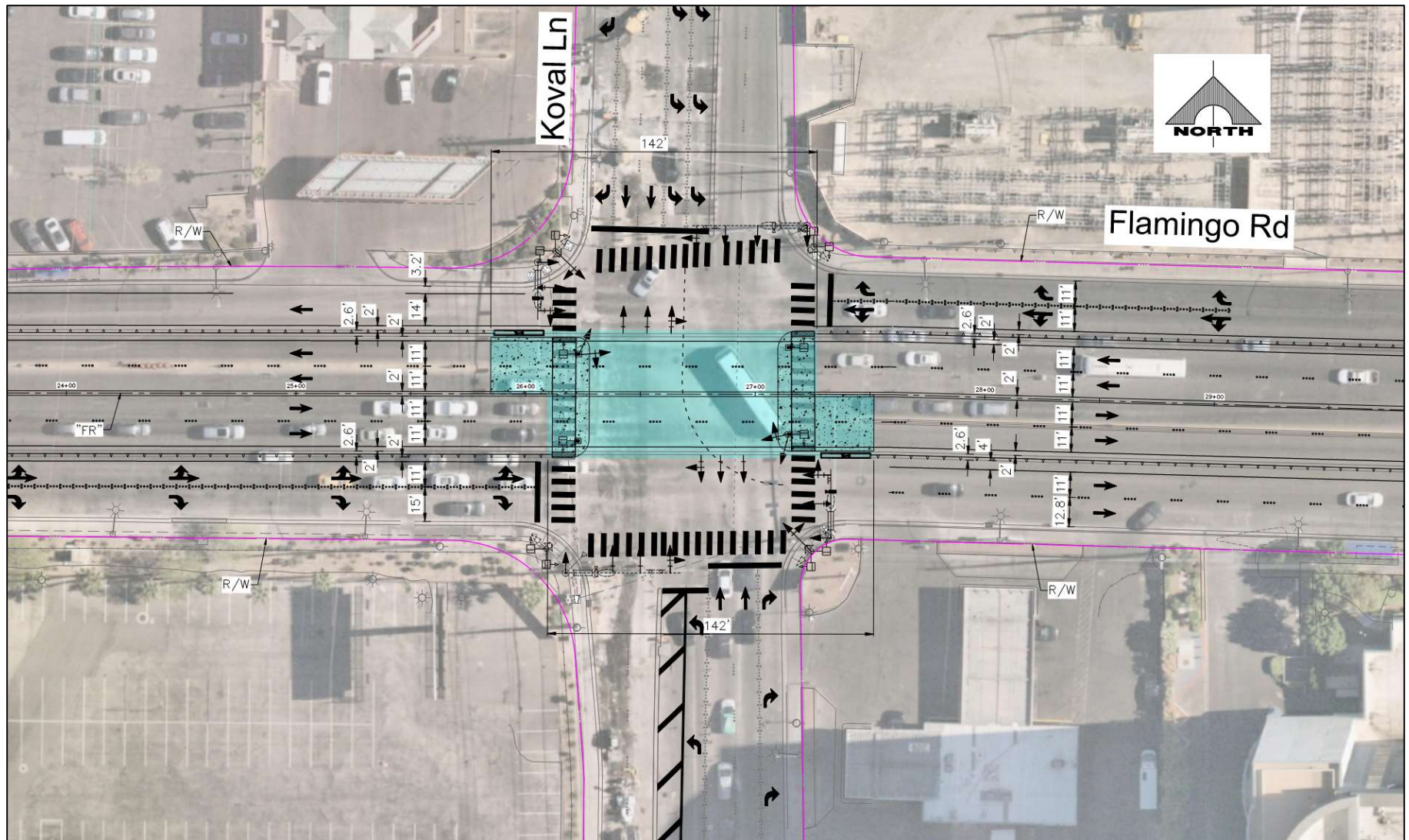

Figure 11. Conceptual Layout of a Permanent Four-Lane Bridge for Flamingo Road Over Koval Lane

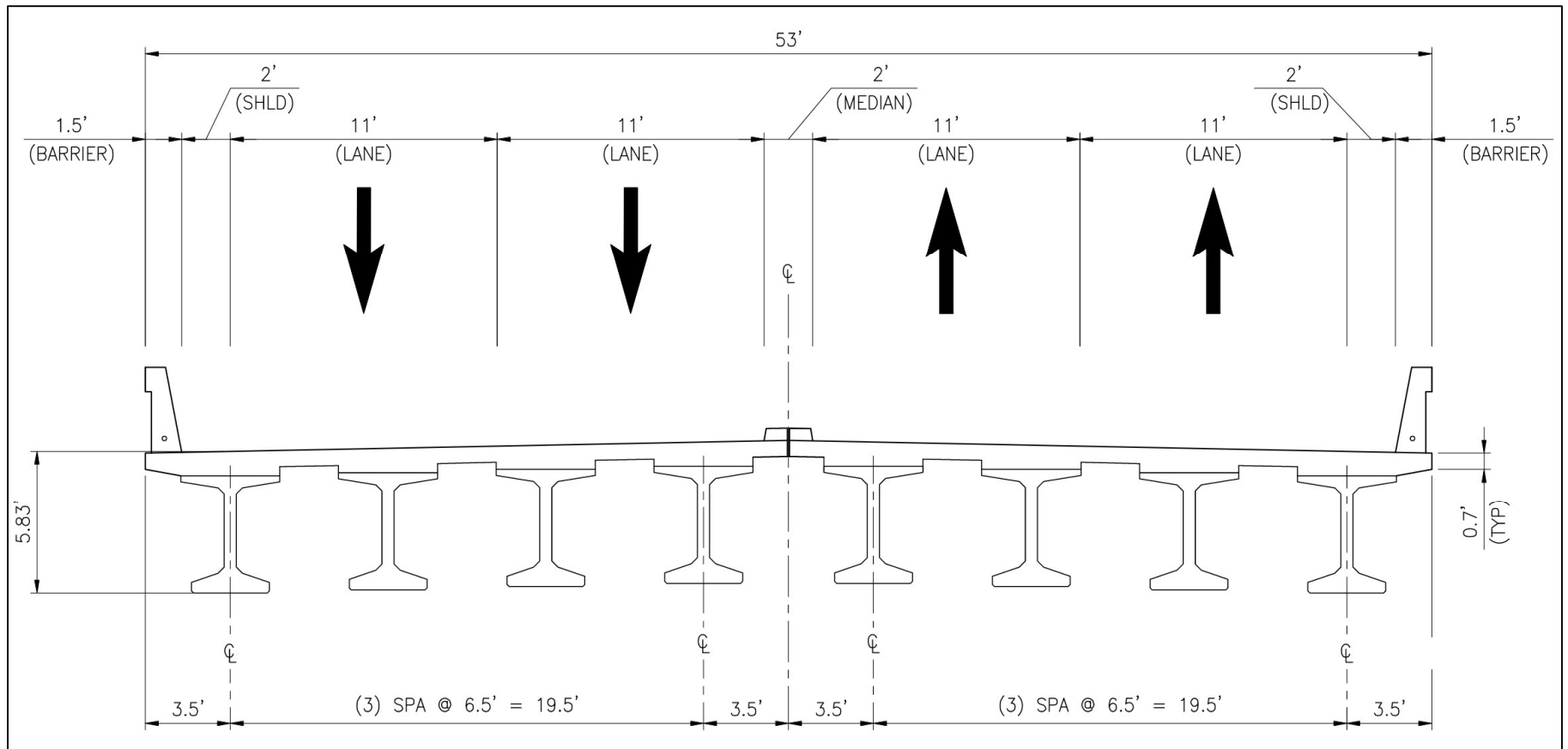
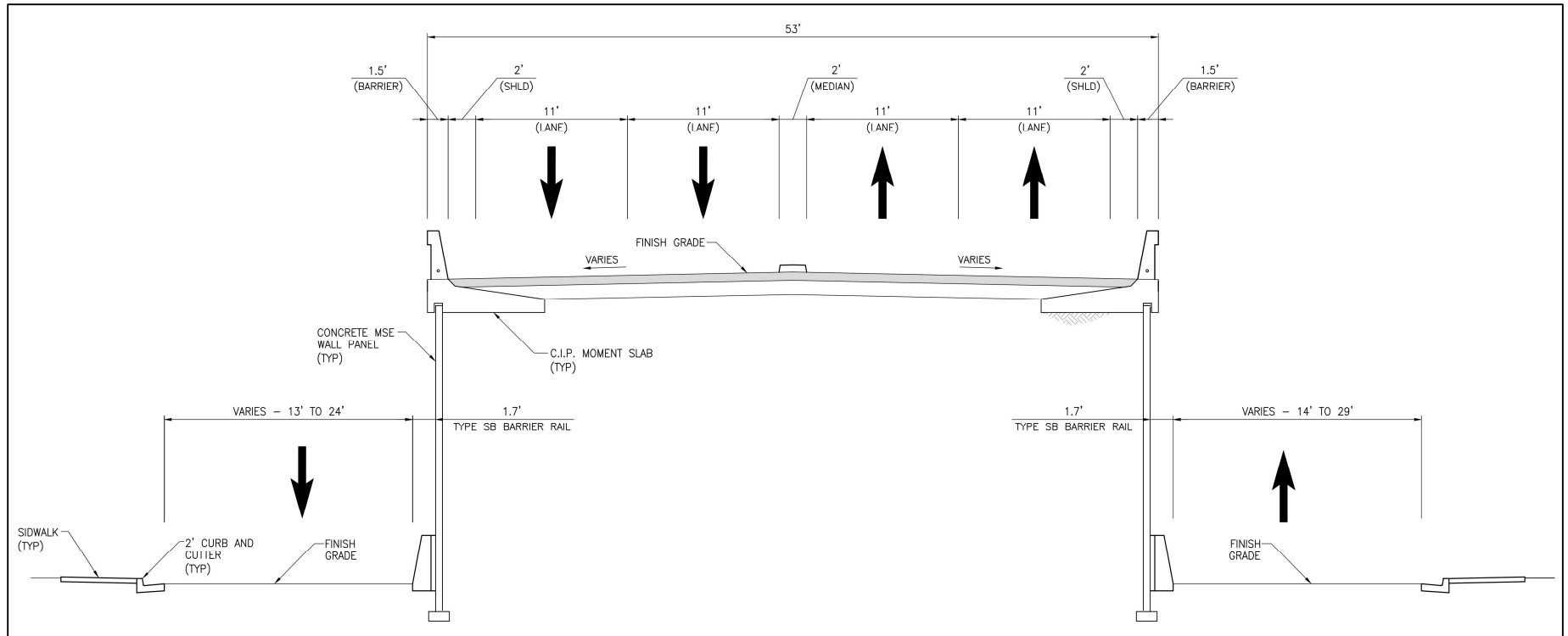

Figure 12. Conceptual Cross-Section for a Permanent Four-Lane Bridge



**Figure 13. Conceptual Cross-Section for an Elevated Approach for a Permanent Four-Lane Bridge**

Table 10 provides a concept level cost estimate for the construction of a permanent bridge for Flamingo Road over Koval Lane.

**Table 10. Concept Level Estimated Cost for Construction of a Permanent Four-Lane Bridge**

Item	Estimated Cost
Bridge	\$8,160,000
Roadway and Sidewalks	\$1,462,000
Drainage	\$2,000,000
Traffic Signals and Lighting	\$546,000
Signing and Striping	\$40,000
Utility Relocations	\$3,700,000
Indirect Construction Costs	\$2,815,000
Subtotal	\$18,723,000
Contingency (30%)	\$5,617,000
Subtotal Construction	\$24,340,000
Professional Services (15%)	\$3,651,000
<b>Total Estimated Project Cost</b>	<b>\$27,991,000</b>

The conceptual layout of a permanent four-lane bridge is configured within the existing right-of-way of Flamingo Road and Koval Lane. However, the acquisition of right-of-way alongside the bridge could be considered to accommodate standard lane widths and/or accommodate the largest trucks.

Flamingo Road has an existing raised median extending from Linq Lane to Koval Lane and from Koval Lane to Howard Hughes Parkway. As such, all properties currently fronting Flamingo Road from Linq Lane to Howard Hughes Parkway only have right-turn-in/right-turn-out driveway access, with the exception of the Westin Hotel which has a median break for a left-turn-in from eastbound Flamingo Road. Due to its proximity to Koval Lane, the left-turn into the Westin Hotel driveway was temporarily closed with the temporary bridge and would not be available with a permanent bridge.

Properties with access driveways alongside the temporary bridge used the at-grade ramps alongside the temporary bridge for vehicular access while the temporary bridge was in place. Similarly, with a permanent bridge, properties with existing or future access driveways alongside the permanent bridge would use the at-grade ramps alongside the permanent bridge for vehicular access.



## 12. FLAMINGO ROAD CORRIDOR ANALYSIS

Improvements in the Flamingo Road/Koval Lane intersection may affect the larger Flamingo Road Corridor. Specifically, a Flamingo Road bridge over Koval Lane may affect the traffic signal progression along Flamingo Road as traffic would no longer form platoons crossing Koval Lane.

To evaluate the potential effect of a Flamingo Road bridge over Koval Lane, the Flamingo Road Corridor was modeled from Las Vegas Boulevard to Paradise Road using the TransModeler traffic simulation model. The following five intersections were included in the model:

- Flamingo Road & Las Vegas Boulevard,
- Flamingo Road & Linq Lane,
- Flamingo Road & Koval Lane,
- Flamingo Road & Howard Hughes Parkway, and
- Flamingo Road & Paradise Road.

Figure 14 shows the estimated Year 2024 AM and PM peak hour traffic volumes in the Flamingo Road Corridor. These traffic volumes were used as inputs to the TransModeler simulation model. Pedestrian crossing volumes are included in the model as shown in Figure 14 for the Koval Lane and the Linq Lane intersections. Because of high pedestrian volumes at these intersections, pedestrian crossings are taken into consideration in traffic signal timing and phasing. The Flamingo Road/Las Vegas Boulevard intersection is equipped with pedestrian bridges, so there are no at-grade pedestrian crossings at the intersection.

Table 11 shows the estimated peak hour travel time delay in the Flamingo Corridor, from Las Vegas Boulevard to Paradise Road, under existing conditions and with a bridge over Koval Lane, as

developed with the model. With a Flamingo Road bridge over Koval, the model included an at-grade intersection beneath the Koval bridge with the improved configuration of Alternative 1B with a temporary bridge or Alternative 2 with a permanent bridge.

With a bridge over Koval Lane, corridor-wide peak hour delay is estimated to decrease by 18.0 vehicle hours in the AM peak hour and by 32.2 hours in the PM peak hour. Generally, with a bridge, individual intersection delay is not estimated to change substantially at the Las Vegas Boulevard, Howard Hughes Parkway, or Paradise Road intersections. Delays for Koval Lane traffic using the at-grade intersection beneath the temporary or permanent bridge would remain about the same as under existing conditions, while traffic crossing over Koval Lane would not experience delays. However, in the PM peak hour, delays in the Linq Lane intersection are estimated to increase substantially with either a temporary or a permanent bridge.

In the PM peak hour, traffic signal progression breaks down and the Flamingo Road intersections at Las Vegas Boulevard and Linq Lane operate at Level-of-Service F with or without a bridge. Under existing conditions, in the PM peak hour, traffic backs up from the Linq Lane intersection almost to Koval Lane on each signal cycle. With a bridge over Koval Lane, westbound traffic does not platoon at Koval Lane but continues through to Linq Lane without stopping. As a result, traffic is able to back up from Linq Lane onto the overpass bridge. Rather than experiencing delays at Koval Lane and at Linq Lane sequentially, traffic in the westbound direction crosses over Koval lane without stopping and then experiences longer delays at the Linq Lane intersection.



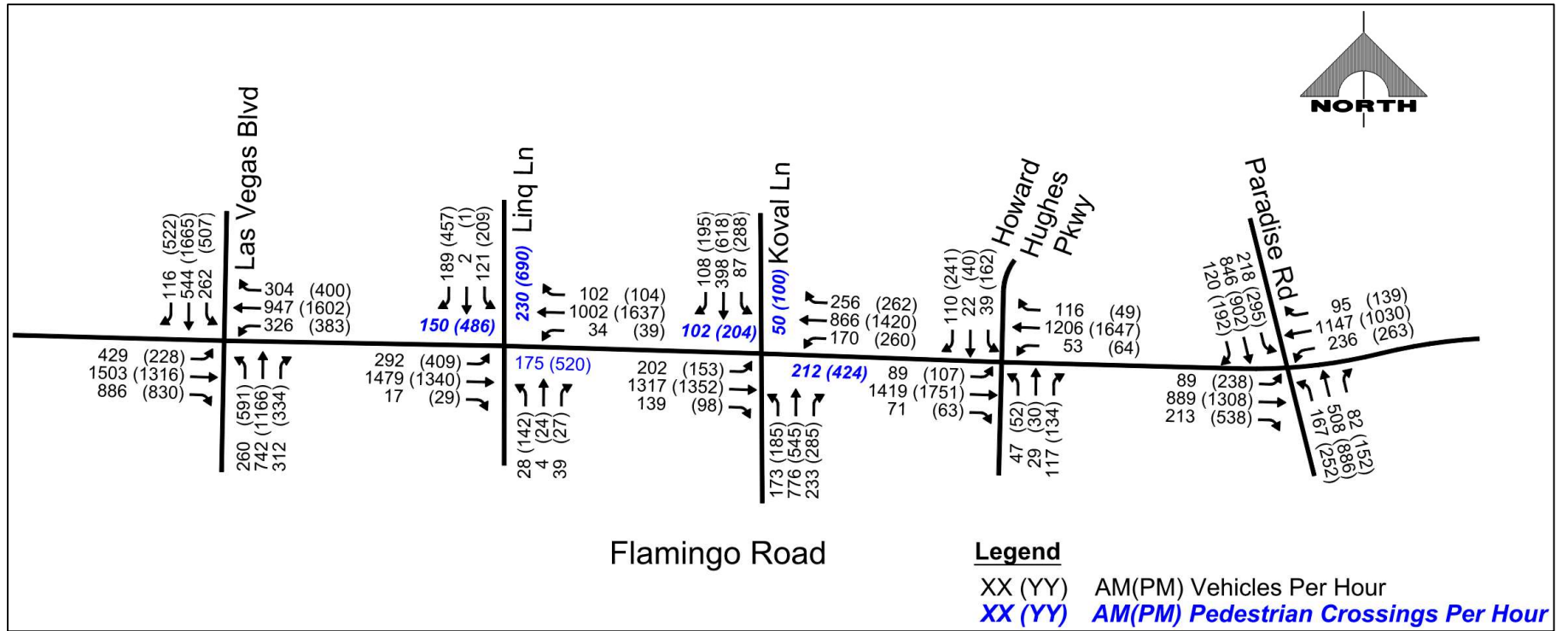

Figure 14. Flamingo Corridor 2024 Peak Hour Traffic Volumes, Las Vegas Boulevard to Paradise Road





**Table 11. Estimated Peak Hour Travel Time Delay in the Flamingo Road Corridor (Las Vegas Boulevard to Paradise Road) under Existing Conditions and with a Four-Lane Flamingo Road Bridge over Koval Lane**

Intersection	Vehicles/Hour		Total Corridor Delay (Vehicle-hours)		Average Delay/Vehicle (Seconds)		Intersection Level-of-Service	
	AM Peak	PM Peak	AM Peak	PM Peak	AM Peak	PM Peak	AM Peak	PM Peak
<i>Existing Corridor</i>								
Flamingo & Las Vegas Blvd	6,603	8,110	72.90	292.50	35.7	127.7	D	F
Flamingo & Linq	3,279	3,740	32.22	97.94	35.4	94.3	D	F
Flamingo & Koval	4,720	5,118	37.56	117.98	28.7	83.0	C	F
Flamingo & Howard Hughes	3,308	3,859	16.98	58.86	18.5	54.9	B	D
Flamingo & Paradise	4,591	5,866	50.64	105.94	39.7	65.0	D	E
<b>Total Existing Corridor</b>	<b>22,501</b>	<b>26,693</b>	<b>210.31</b>	<b>673.22</b>				
<i>Corridor with Bridge at Koval</i>								
Flamingo & Las Vegas Blvd	6,626	8,155	65.52	293.90	35.6	129.8	D	F
Flamingo & Linq	3,286	3,706	35.44	150.22	38.8	145.9	D	F
Flamingo & Koval	2,572*	2,599*	31.76	55.16	44.5	76.4	D	E
Flamingo & Howard Hughes	3,316	3,869	9.70	44.94	10.5	41.8	B	D
Flamingo & Paradise	4,608	5,874	49.90	96.78	39.0	59.3	D	E
<b>Total Corridor with Bridge</b>	<b>20,408*</b>	<b>24,003*</b>	<b>192.32</b>	<b>656.96</b>				
<b>REDUCTION IN TOTAL PEAK HOUR DEALY WITH BRIDGE</b>			<b>18.0</b>	<b>32.22</b>				

\* Number of vehicles reduced because vehicles driving over the bridge without delay are excluded from delay calculations



With the temporary bridge in place, westbound traffic was not observed backing up to the temporary bridge because the traffic volume on Flamingo Road was only a fraction of normal traffic.

Numerically, in the PM peak hour, while total delay in the Koval Lane intersection decreases from 117.98 vehicle-hours under existing conditions to 55.16 vehicle-hours with a bridge, these savings are counterbalanced by total delay in the Linq Lane intersection increasing from 97.94 vehicle-hours to 145.9 vehicle hours. In other words, in the westbound direction, most of time that is saved by speeding over Koval Lane on a bridge without stopping is generally lost due to additional delays at Linq Lane.

In the eastbound direction, in the PM peak hour, traffic is metered through the Las Vegas Boulevard intersection and because the Paradise Road intersection is not operating at Level-of-Service F, time that is saved by speeding over Koval Lane on a bridge does not result in greater delays at Paradise Road.

Table 12 shows the estimated corridor-wide net present value of erecting, operating, and dismantling a temporary bridge annually for 9 years, from 2024 through 2032, with Alternative 1B - Improved traffic signal phasing and timing of the at-grade intersection and the addition of an eastbound Flamingo Road to southbound Koval Lane right-turn lane. Corridor-wide benefits are not sufficient to offset the disbenefits of traffic disruption during the erection and dismantling of the temporary bridge so that over the potential 9 years that a temporary bridge could be employed there would be a potential \$13.8 million loss to motorists traveling through the Flamingo Road corridor.

**Table 12. Estimated Corridor-Wide Travel Time Benefits (Disbenefits) of Alternative 1B - Temporary Bridge with Traffic Signal Improvements and Added EB Right-Turn Lane**

Year	Daily Travel Time Savings	Annual Travel Times Savings	Closure Costs (22 days)	Present Worth of Benefits (Disbenefits)
2024	\$9,501	\$285,030	\$(2,008,930)	\$(1,723,900)
2025	\$9,501	\$285,030	\$(2,008,930)	\$(1,673,689)
2026	\$9,501	\$285,030	\$(2,008,930)	\$(1,624,941)
2027	\$9,501	\$285,030	\$(2,008,930)	\$(1,577,613)
2028	\$9,501	\$285,030	\$(2,008,930)	\$(1,531,663)
2029	\$9,501	\$285,030	\$(2,008,930)	\$(1,487,051)
2030	\$9,501	\$285,030	\$(2,008,930)	\$(1,443,739)
2031	\$9,501	\$285,030	\$(2,008,930)	\$(1,401,688)
2032	\$9,501	\$285,030	\$(2,008,930)	\$(1,360,863)

**Alternative 1B - Total Net Present Value of Corridor-Wide Travel Time Benefits/(Disbenefits) = \$(13,825,147)**

Table 13 shows the estimated corridor-wide net present value of constructing and operating a permanent bridge. The corridor-wide net present value of the benefits to motorists of a permanent bridge is estimated to be \$41.5 million based on a 20-year economic life. This would provide a benefit/cost ratio of (\$41.5M/28.0M =) 1.48.

With either a temporary bridge or a permanent bridge, motorists achieve time savings by passing over Koval Lane without stopping. However, particularly in the PM peak hour, these time savings are largely offset by increased delays at the Linq Lane intersection.



**Table 13. Estimated Corridor-Wide Travel Time Benefits (Disbenefits) of Alt. 2 – Permanent Four-Lane Bridge**

Year	Daily Travel Time Savings	Annual Travel Times Savings	Closure Costs (12 months)	Present Worth of Benefits (Disbenefits)
2024				
2025				
2026			\$(7,568,669)	\$(7,134,197)
2027	\$9,501	\$3,467,865	\$0	\$3,173,588
2028	\$9,501	\$3,467,865	\$0	\$3,081,153
2029	\$9,501	\$3,467,865	\$0	\$2,991,411
2030	\$9,501	\$3,467,865	\$0	\$2,904,282
2031	\$9,501	\$3,467,865	\$0	\$2,819,692
2032	\$9,501	\$3,467,865	\$0	\$2,737,565
2033	\$9,501	\$3,467,865	\$0	\$2,657,830
2034	\$9,501	\$3,467,865	\$0	\$2,580,417
2035	\$9,501	\$3,467,865	\$0	\$2,505,259
2036	\$9,501	\$3,467,865	\$0	\$2,432,291
2037	\$9,501	\$3,467,865	\$0	\$2,361,447
2038	\$9,501	\$3,467,865	\$0	\$2,292,667
2039	\$9,501	\$3,467,865	\$0	\$2,225,891
2040	\$9,501	\$3,467,865	\$0	\$2,161,059
2041	\$9,501	\$3,467,865	\$0	\$2,098,115
2042	\$9,501	\$3,467,865	\$0	\$2,037,005
2043	\$9,501	\$3,467,865	\$0	\$1,977,675
2044	\$9,501	\$3,467,865	\$0	\$1,920,073
2045	\$9,501	\$3,467,865	\$0	\$1,864,148
2046	\$9,501	\$3,467,865	\$0	\$1,809,853

**Alternative 2 - Total Net Present Value of Corridor-Wide Travel Time Benefits/(Disbenefits) = \$41,497,224**

To evaluate the time required to drive through the Flamingo Road Corridor, with and without a temporary bridge over Koval Lane, dozens of vehicular trips were driven along Flamingo Road from Las Vegas Boulevard to Paradise Road, while the temporary bridge was in place and after the temporary bridge was taken down, with the travel times and stop times recorded. Table 14 provides a summary of the travel times recorded:

- On December 19 – 21, 2023, with the temporary bridge in place, and
- On February 7, 2024, after the temporary bridge was removed.



**Table 14. Recorded Vehicular Travel Times through the Flamingo Road Corridor, Las Vegas Boulevard to Paradise Road, with Recorded Stop Times and Average Speeds**

Scenario	Mid-Day	PM Peak
	Avg. Travel Time (min)	
Existing Flamingo Road w/o a bridge	5.30	6.90
Flamingo Road for traffic using the temporary bridge	4.50	4.24
Flamingo Road for traffic using the ramps alongside the temporary bridge	5.92	6.56
	Avg Stop Time (min)	

Travel times and stop times were recorded during the midday and PM peak periods. Travel time included the time passing through the Las Vegas Boulevard and Paradise Road intersections on both ends of the Corridor. Stop times were recorded as the time spent stopped at traffic signals. When the temporary bridge was in place, corridor travel times were recorded for vehicles passing over Koval Lane on the temporary bridge and for vehicles using the ramps alongside the bridge to pass through the at-grade intersection at Koval Lane. The total distance driven was approximately 1.4 miles in each direction.

The travel time data yields predictable results:

- Under existing conditions, without a temporary bridge, travel speeds through the Flamingo Road Corridor averaged 16.6 mph at midday and slowed to 12.7 mph in the PM peak period, requiring 5.30 to 6.90 minutes to traverse the Corridor, at midday and during the PM peak period, respectively.

Existing Flamingo Road w/o a bridge	2.27	3.68
Flamingo Road for traffic using the temporary bridge	1.75	1.52
Flamingo Road for traffic using the ramps alongside the temporary bridge	2.80	3.50
	Avg Speed (mph)	
Existing Flamingo Road w/o a bridge	16.6	12.7
Flamingo Road for traffic using the temporary bridge	19.5	19.4
Flamingo Road for traffic using the ramps alongside the temporary bridge	13.9	12.5

- With the temporary bridge in place, travel speeds for motorists using the bridge to cross over Koval Lane without stopping were approximately 19.5 mph both at midday and during the PM peak period, only requiring 4.24 to 4.50 minutes to traverse the corridor, in the PM peak period and midday, respectively. However, it is not possible to determine if the 0.80-to-2.66-minute time savings by using the bridge was because of the bridge allowing motorists to avoid the traffic signal at Koval Lane or because traffic volumes on Flamingo Road were approximately 30% lower than normal while the temporary bridge was in place. It was likely a combination of the two.
- It is not surprising that motorists using the ramps to access Koval Lane and pass through the at-grade intersection beneath the bridge encountered 1.05 minutes of additional travel time at midday and 1.98 minutes of additional travel time during the PM peak period while stopped at the traffic signal, compared to motorists who used the bridge to cross over Koval Lane and avoid the traffic signal.



### 13. FLAMINGO ROAD CORRIDOR ANALYSIS – ALTERNATIVE DESIGN WITH BRIDGE ONLY PROVIDING TWO LANES (ONE LANE IN EACH DIRECTION) OVER KOVAL LANE

An alternative was evaluated which considered a bridge for Flamingo Road which would be narrower than the 2023 F1 Configuration temporary bridge, and only wide enough to carry one lane in each direction for Flamingo Road over Koval Lane.

With a narrower width for the bridge, the at-grade Flamingo/Koval intersection could be operated with two lanes for Flamingo Road at-grade.

To evaluate the potential effects of a two-lane Flamingo Road bridge over Koval Lane, the Flamingo Road Corridor was modeled using the TransModeler traffic simulation model.

Table 15 shows the estimated peak hour travel time delay in the Flamingo Corridor, from Las Vegas Boulevard to Paradise Road, under existing conditions with a two-lane bridge over Koval Lane, as developed with the model. With a two-lane Flamingo Road bridge over Koval, the model included two at-grade combined through/turning lanes for Flamingo Road and maintained the present lane configuration for Koval Lane.

With a two-lane bridge over Koval Lane, peak hour delay at the Flamingo/Koval intersection improves, but the total corridor peak hour delay increases substantially, by 41.8 vehicle hours in the AM peak hour and by 311.7 vehicle hours in the PM peak hour. While traffic would move more smoothly through the Flamingo/Koval intersection, it backs up from poor signal progression at all the other intersections

without the platooning effect created at Koval Lane. In particular, westbound traffic backs up from Linq Lane across the bridge over Koval Lane.

Table 16 shows the estimated corridor-wide net value of erecting, operating, and dismantling a temporary two-lane (two-way) bridge annually for 9 years, from 2024 through 2032. This configuration does not provide any travel time savings over the corridor and would result in a potential \$26.3 million loss to motorists. This is higher than the corridor-wide loss with a four-lane temporary bridge.

Table 17 shows the estimated corridor-wide net present value of constructing and operating a permanent two-lane (two-way) bridge. The corridor-wide net present value of the disbenefits to motorists is estimated to be \$223 million based on a 20-year economic life. The disbenefits far exceed the cost of a permanent two-lane bridge, so that the benefit/cost ratio would be negative.

The analysis of an alternative using a two-lane bridge (one lane in each direction) for Flamingo Road over Koval Lane did not identify any net benefits for either temporary two-lane bridges or a permanent two-lane bridge.



**Table 15. Estimated Peak Hour Travel Time Delay in the Flamingo Road Corridor (Las Vegas Boulevard to Paradise Road) under Existing Conditions and with a Flamingo Road Two-Lane (Two-Way) Bridge over Koval Lane**

Intersection	Vehicles/Hour		Total Corridor Delay (Vehicle-hours)		Average Delay/Vehicle (Seconds)		Intersection Level-of-Service	
	AM Peak	PM Peak	AM Peak	PM Peak	AM Peak	PM Peak	AM Peak	PM Peak
<i>Existing Corridor</i>								
Flamingo & Las Vegas Blvd	6,603	8,723	72.90	139.08	35.7	57.4	D	E
Flamingo & Linq	3,279	3,710	32.22	46.56	35.4	45.2	D	D
Flamingo & Koval	4,720	5,395	37.56	96.46	28.7	64.4	C	E
Flamingo & Howard Hughes	3,308	4,174	16.98	18.16	18.5	15.7	B	B
Flamingo & Paradise	4,591	5,989	50.64	92.82	39.7	55.8	D	E
<b>Total Existing Corridor</b>	<b>22,501</b>	<b>27,991</b>	<b>210.31</b>	<b>393.08</b>				
<i>Corridor with Bridge at Koval</i>								
Flamingo & Las Vegas Blvd	6,629	8,131	86.78	329.28	47.1	145.8	D	F
Flamingo & Linq	3,254	3,747	65.76	162.64	72.8	156.2	E	F
Flamingo & Koval	2,580*	3026*	30.30	41.80	42.3	49.7	D	D
Flamingo & Howard Hughes	3,298	3,877	14.36	65.08	15.7	60.4	B	E
Flamingo & Paradise	4,568	5,870	54.92	106.00	43.3	65.0	D	E
<b>Total Corridor with Bridge</b>	<b>20,408*</b>	<b>25,627*</b>	<b>252.12</b>	<b>704.80</b>				
<b>REDUCTION/INCREASE IN TOTAL PEAK HOUR DELAY WITH BRIDGE</b>			<b>(41.81)</b>	<b>(311.72)</b>				

\* Number of vehicles reduced because vehicles driving over the bridge without delay are excluded from delay calculations



**Table 16. Estimated Corridor-Wide Travel Time Benefits (Disbenefits) of a Temporary Two-Lane (Two-Way) Bridge**

Year	Daily Travel Time Savings	Annual Travel Times Savings	Closure Costs (22 days)	Present Worth of Benefits (Disbenefits)
2024	\$(42,324)	\$(1,269,720)	\$(2,008,930)	\$(3,278,650)
2025	\$(42,324)	\$(1,269,720)	\$(2,008,930)	\$(3,183,155)
2026	\$(42,324)	\$(1,269,720)	\$(2,008,930)	\$(3,090,442)
2027	\$(42,324)	\$(1,269,720)	\$(2,008,930)	\$(3,000,429)
2028	\$(42,324)	\$(1,269,720)	\$(2,008,930)	\$(2,913,038)
2029	\$(42,324)	\$(1,269,720)	\$(2,008,930)	\$(2,828,192)
2030	\$(42,324)	\$(1,269,720)	\$(2,008,930)	\$(2,745,818)
2031	\$(42,324)	\$(1,269,720)	\$(2,008,930)	\$(2,665,842)
2032	\$(42,324)	\$(1,269,720)	\$(2,008,930)	\$(2,588,197)

**Alternative 1B - Total Net Present Value of Corridor-Wide Travel Time Benefits/(Disbenefits) = \$(26,293,764)**

**Table 17. Estimated Corridor-wide Travel Time Benefits (Disbenefits) of a Permanent Two-Lane (Two-Way) Bridge**

Year	Daily Travel Time Savings	Annual Travel Times Savings	Closure Costs (12 months)	Present Worth of Benefits (Disbenefits)
2024				
2025				
2026			\$(7,568,669)	\$(7,134,197)
2027	\$(42,324)	\$(15,448,260)	\$0	\$(14,137,346)
2028	\$(42,324)	\$(15,448,260)	\$0	\$(13,725,579)
2029	\$(42,324)	\$(15,448,260)	\$0	\$(13,325,805)
2030	\$(42,324)	\$(15,448,260)	\$0	\$(12,937,675)
2031	\$(42,324)	\$(15,448,260)	\$0	\$(12,560,849)
2032	\$(42,324)	\$(15,448,260)	\$0	\$(12,194,999)
2033	\$(42,324)	\$(15,448,260)	\$0	\$(11,839,805)
2034	\$(42,324)	\$(15,448,260)	\$0	\$(11,494,956)
2035	\$(42,324)	\$(15,448,260)	\$0	\$(11,160,152)
2036	\$(42,324)	\$(15,448,260)	\$0	\$(10,835,099)
2037	\$(42,324)	\$(15,448,260)	\$0	\$(10,519,513)
2038	\$(42,324)	\$(15,448,260)	\$0	\$(10,213,120)
2039	\$(42,324)	\$(15,448,260)	\$0	\$(9,915,650)
2040	\$(42,324)	\$(15,448,260)	\$0	\$(9,626,845)
2041	\$(42,324)	\$(15,448,260)	\$0	\$(9,346,451)
2042	\$(42,324)	\$(15,448,260)	\$0	\$(9,074,225)
2043	\$(42,324)	\$(15,448,260)	\$0	\$(8,809,927)
2044	\$(42,324)	\$(15,448,260)	\$0	\$(8,553,327)
2045	\$(42,324)	\$(15,448,260)	\$0	\$(8,304,201)
2046	\$(42,324)	\$(15,448,260)	\$0	\$(8,062,331)

**Alternative 2 - Total Net Present Value of Corridor-Wide Travel Time Benefits/(Disbenefits) = \$(223,772,051)**



#### 14. FLAMINGO ROAD CORRIDOR DIRECT AND INDIRECT IMPACTS

During the construction of the temporary bridge for the F1 Race, Flamingo Road was temporarily closed to through traffic from Ling Lane to Howard Hughes Parkway, and Koval Lane was temporarily closed to through traffic from Winnick Road to Harmon Avenue. Access to properties within these limits was restricted to approaches from the north, south, east, and west, without crossing the Flamingo/Koval intersection. In addition to requiring detours and alternate routes to access properties, businesses could not attract drive-by traffic and dedicated customers were subjected to inconvenient detours.

While the temporary bridge was in operation, local properties on Flamingo Road and on Koval Lane were subject to direct and indirect impacts.

Direct impacts included:

- Temporary closure of the left-turn lane from eastbound Flamingo Road into the Westin Hotel driveway.
- Difficulty in accessing driveways, requiring awkward U-turns and restricted movements through the temporarily modified at-grade Flamingo/Koval intersection.
- Excessive delays in passing through the temporarily modified at-grade Flamingo/Koval intersection.
- Conflicts between pedestrians and turning vehicles in the temporarily modified at-grade Flamingo/Koval intersection.

The direct economic losses to motorists from increased travel time, discussed above, amounted to an estimated \$2 million

during closures for the construction and dismantling of the temporary bridge and an additional \$8,500 per day while the bridge was in use.

Indirect impacts were less tangible but can be correlated with the overall public avoidance of the Flamingo Road Corridor while the bridge was in-place. Specifically, traffic volumes on Flamingo Road and on Koval Lane decreased by at least 30% while the temporary bridge was in use. Rather than viewed as a convenient vehicular grade separation speeding east-west travel, the likely public perception was that Flamingo Road and Koval Lane were in a temporary detoured condition similar to that experienced in a construction zone.

Lengthy traffic signal delays in the at-grade modified Flamingo/Koval intersection undoubtedly caused motorists to avoid Koval Lane. For example, more than half of the motorists who normally pass through the Flamingo/Koval intersection to access Resort Corridor employee parking from Koval Lane used alternate routes for their commute to work.

There is a likely correlation between lowered traffic volumes and reduced business activity. However, without a measurement of normal business activity, it would be difficult to estimate the economic impact of a 30% reduction in traffic. None the less, since the temporary bridge during the 2023 F1 Race did not provide any net benefits to the traveling public, any potential losses from reduced business activity would merely add to the disbenefits of the temporary bridge.

For future F1 Races, if the two-way temporary bridge will continue to be used, actions should be considered so that fewer motorists





avoid the Flamingo Road Corridor when the temporary bridge is in use, to reduce the impacts of reduced business activity. These actions include:

- Installing a temporary traffic signal at the Flamingo Road/Koval intersection to improve the timing and phasing of the temporary at-grade intersection,
- Configuring the temporary at-grade intersection to add turning lanes, and
- Providing a temporary pedestrian bridge over Koval Lane 24-hours/day, 7-days/week for the entire time that the temporary bridge is in-place.

While these actions would not be sufficient for a temporary bridge to provide net benefits, they could reduce the volume of traffic that chooses to avoid the Flamingo Corridor while the bridge is in use. In this regard, in addition to the above, minimizing the length of time that the temporary bridge is in-place would improve business activity in the corridor.

As an alternative to the 2023 F1 Configuration temporary bridge, which carried two-way Flamingo Road traffic over Koval Lane, only constructing an eastbound two-lane structure to only carry eastbound Flamingo Road over Koval Lane would not only reduce travel time losses for motorists but could also substantially reduce the impacts of reduced business activity. Specifically, with only an eastbound temporary bridge, impacts to business activity would be reduced:

- By only closing eastbound Flamingo Road during the erection and dismantling of the eastbound temporary bridge, while maintaining westbound Flamingo Road open

to traffic, diversion of traffic during construction would be very substantially decreased.

- By maintaining three existing westbound general purpose travel lanes at-grade while the temporary bridge is in-place, access from westbound Flamingo Road would not be changed and all traffic would remain at-grade along westbound business frontage.
- By preserving the eastbound left-turn into the Westin Hotel while the bridge is in-place.
- By maintaining one existing at-grade eastbound general purpose travel lane at-grade, separate from left and right-turn lanes, access to businesses from eastbound Flamingo Road would not be blocked by turning vehicles.
- By preserving access to Koval Lane from Flamingo Road with dedicated right and left-turn lanes from eastbound Flamingo Road to northbound and southbound Koval Lane.

With only an eastbound temporary bridge over Koval Lane, motorists would be less likely to avoid the Flamingo Road Corridor so that travel time losses to motorists would be the lowest of any temporary bridge alternative and losses in business activity would be reduced to the extent that they are tied to traffic volumes. However, the temporary bridge would be restricted to emergency vehicles only during the hours of the actual F1 Race.

With only an eastbound temporary bridge over Koval Lane, additional actions that could be taken to reduce delays in the at-grade intersection so that fewer motorists avoid the Flamingo Road Corridor, to reduce the impacts of reduced business activity include:



- Temporarily modifying the traffic signal at the Flamingo Road/Koval Lane Intersection to optimize the timing and phasing for the modified intersection lane configuration.

As an alternative to continued use of temporary bridges, a permanent bridge could be configured to provide higher design speeds, improve the at-grade intersection configuration, improve traffic signal timing and phasing, and improve the ability to make U-turns. With a permanent installation, traffic volumes could be expected to return to normal after the bridge is constructed and to remain normal except for the short period of time when Koval Lane is temporarily closed for the actual F1 annual race.

Unfortunately, a permanent bridge would require approximately one year to construct. Traffic modeling suggests that, during construction of a permanent bridge, an approximately 50% reduction in traffic on Flamingo Road could be expected at Koval Lane. In addition to an estimated \$7 million direct economic impact to motorists from additional travel time during construction, there would be indirect impacts to business activity in the Flamingo Road Corridor due to lowered traffic volumes. Because the benefit/cost ratio for a permanent bridge is only 1.05, any indirect costs from reduced business activity would reduce the benefit/cost ratio below 1 for a permanent bridge.

It may be concluded that temporary bridges do not provide net positive economic benefits regardless of whether indirect economic impacts to local businesses are considered, and that for a permanent bridge, consideration of any level of indirect economic impact to local businesses would result in costs which exceed potential benefits.

Looking at the Flamingo Road Corridor in isolation, neither temporary bridges nor a permanent bridge would provide net benefits within the Flamingo Road Corridor which would justify their construction. Therefore, either alternative can only be evaluated based on the net valley-wide positive economic impact associated with Formula 1.

The bridge alternative which will cause least travel time losses for motorists and is likely to maintain the highest volume of traffic in the Flamingo Road Corridor, therefore potentially reducing impacts to business activity, is Alternative 1C, an eastbound temporary bridge.



## 15. CONCLUSIONS

A. During the November 2023 F1 Race, the temporary bridge carrying Flamingo Road traffic over Koval Lane was key to maintaining accessibility to the center of the racetrack, especially for emergency services. Maintaining this access is important, however, erecting, operating, and dismantling a temporary bridge each year has undesirable consequences:

- The closures of Flamingo Road and Koval Lane resulted in up to an estimated additional 41,000 vehicle miles of travel per day and up to an estimated additional 2,850 vehicle hours of travel per day for the diverted traffic.
- While the temporary bridge was in-place, local motorists experienced an estimated additional travel time of 295 hours per day, primarily because they selected alternative routes to avoid both Flamingo Road and Koval lane during this time period.
- The poor configuration and operation of the Koval Lane at-grade intersection under the temporary bridge seemed to cause the majority of motorists to stay away from Koval Lane due to excessive intersection delays.

B. If the two-way temporary bridge is installed annually for F1 races through 2032, the cumulative economic disbenefit is estimated to be an \$18.2 million loss to motorists from increased travel delays. To improve the operations of the temporary two-way bridge, lane configuration revisions and traffic signal phasing/timing modifications are recommended for the at-grade Koval Lane intersection

under the bridge (See Figure 7). These improvements would help reduce the excessive delays encountered in 2023, saving motorists an estimated \$3.5 million in travel time costs. However, even with an improved intersection operation, road closures during erection and disassembly of the temporary bridge will result in an estimated net loss for motorists of nearly \$2 million each year from increased travel delays.

- C. If an eastbound two-lane temporary bridge (Alternative 1C) is installed annually for the F1 races through 2032, in lieu of a two-way temporary bridge, the cumulative economic disbenefit is estimated to be a \$5.9 million loss to motorists from increased travel delays. While still technically a loss, the loss would be \$12.2 million less than experienced with the two-way 2023 F1 Configuration. Additionally, Alternative 1C would be expected to have less impact on business activity than the 2023 F1 Configuration temporary bridge, since motorists would be less likely to avoid the Flamingo Road Corridor while the bridge is erected, operated, and dismantled.
- D. Without the F1 Race, the Flamingo Road/Koval Lane intersection would not normally be considered a candidate for a bridge due to the following:
- The existing Flamingo Road/Koval Lane intersection is operating at a satisfactory level-of-service.
  - The existing bottlenecks in the Flamingo Road Corridor are at the Las Vegas Boulevard and the Linq Lane intersections, where congestion mitigation would have greater benefits.



E. A permanent bridge for the Flamingo Road/Koval Lane intersection would provide the same accessibility for the F1 races that is provided by temporary bridges. Compared to a temporary bridge, a permanent bridge would have the following advantages and disadvantages:

Advantages:

- Allow traffic to cross over Koval Lane without stopping on a permanent basis, rather than just a few weeks each year.
- Provide long-term economic benefits from time savings which would slightly exceed the cost of the permanent bridge.

Disadvantages:

- Require approximately one-year to construct, with extended lane closures on Flamingo Road.
- Incur long-term maintenance costs.
- Exacerbate intersection delays at the adjacent Linq Lane intersection.
- Due to the proximity of the Westin Hotel driveway to Koval Lane, eastbound-to-northbound left-turn from Flamingo Road into the Westin Hotel would be permanently blocked and restricted to right-in/right-out. This would require hotel traffic to make a U-Turn at Koval Lane. The eastbound left-turn movements into the Westin Hotel were temporarily closed when the temporary bridge was in place.

F. While all the temporary and permanent bridge alternatives would cause travel time delays for motorists and potentially adversely affect business activity in the Flamingo Road Corridor, Alternative 1C, an eastbound two-lane temporary bridge, would have the least impact, particularly in the near term.





1555 S Rainbow Boulevard  
Las Vegas, NV 89146